

LSA42-4 Front View

Click on any circled item, then add the part to your cart. If it won't click, the part is not available. If the part is not available, please call us at: 888.988.4546

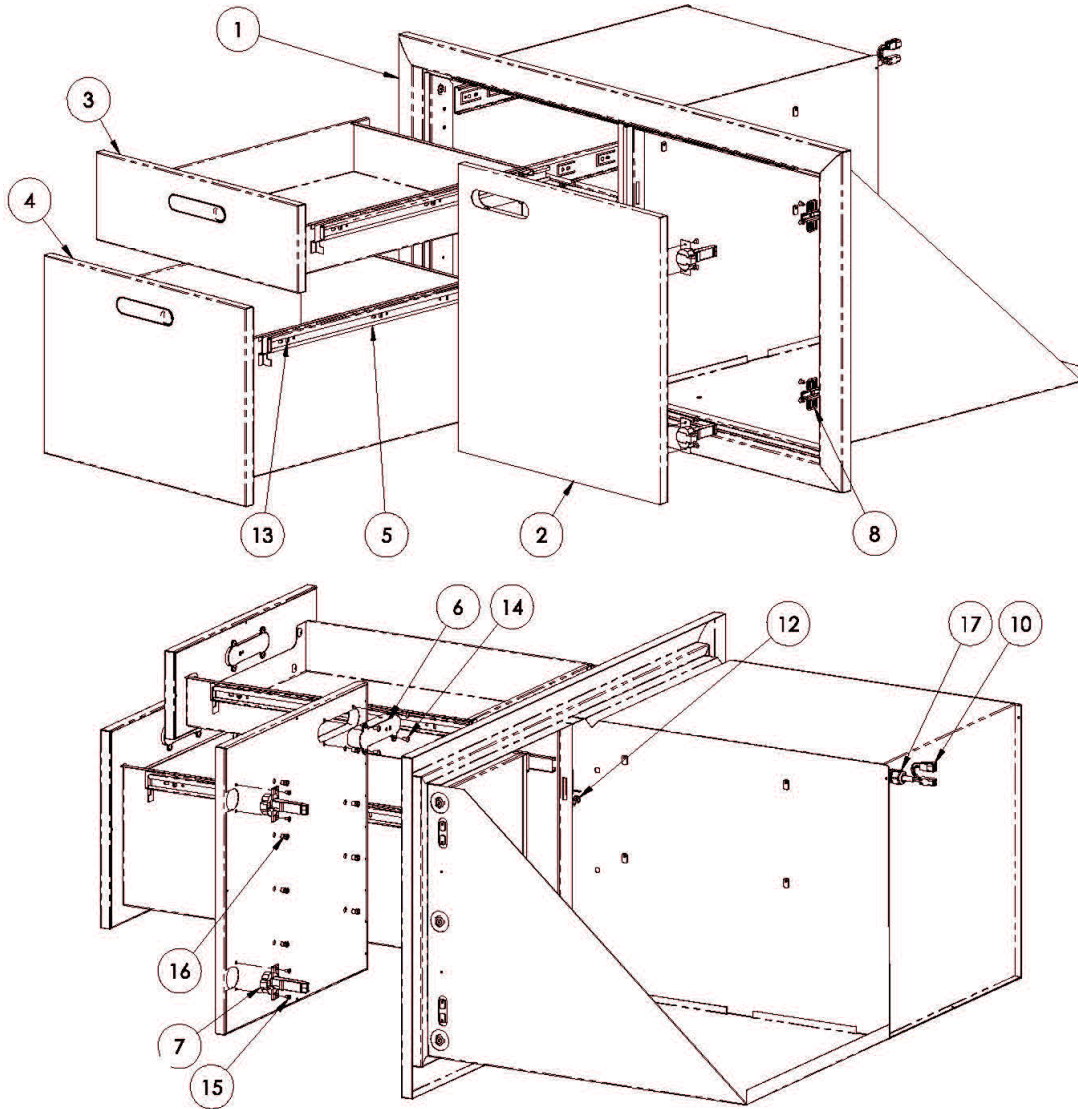

Item	Part No.	Name	Qty	Uom	NOTES
1	70447	CHASSIS, LSA 42, WLDMT	1	EA	
2	70462	DOOR, RIGHT, 42, WLDMT	1	EA	
3	81017	DRAWER, SM, 42, ASSY	1	EA	
4	81018	DRAWER, LG, 42, ASSY	1	EA	
5	34731	DRAWER SLIDE, 22", SOFT CLOSE	4	EA	
6	81019	HANDLE, FLUSH, ASSY	1	EA	
7	35624	HINGE, SOFT CLOSE	2	EA	
8	35792	MOUNTING PLATE, HINGE, SOFT CLOSE	2	EA	
10	70218	HARNESS, POWER, (LPA)	1	EA	
12	35623	GROMMET, RBR, 1/4 I.D. X 1/2 O.D.	1	EA	
13	33517	SCREW, #8-32 X 3/16, PHP, SS	16	EA	
14	14014	SCREW #8-32 x 3/8 PH TRUSS HEAD S/S	4	EA	
15	32644	SCREW, #8-32 X 5/16 PH, FLAT HD	8	EA	
16	32768	NUT, #10-32, INSERT, STEEL, ZINC	8	EA	
17	32632	CORD GRIP, LIQUID TIGHT, .23"-.40"	1	EA	
NI	35749	SEAL, SILICONE, GASKETING	14FT	EA	