

Ref #	Part Number	Qty.	Description
1	033119-000	1	RD-VK-15-R4, CLEAR GLASS W/WOOD BORDER DOOR PAN...
2	033021-000	1	HINGE KIT, RH
3	033069-000	1	DOOR GASKET, 15
4	033015-000	2	PLUNGER FASTENER
5	032973-000	1	PLUNGER BRACKET

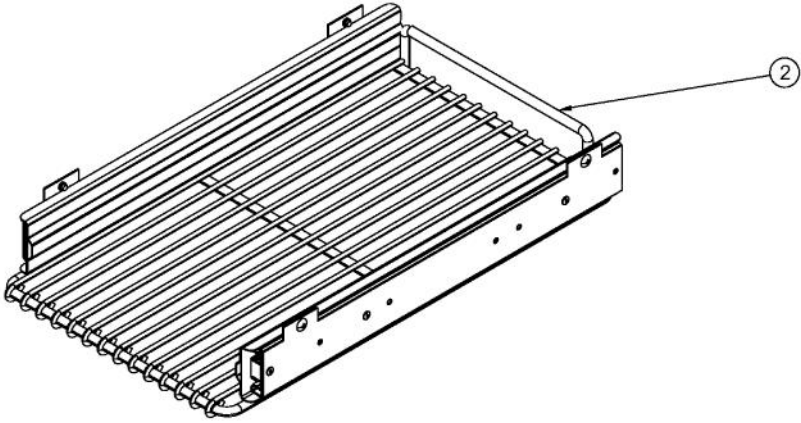

Ref #	Part Number	Qty.	Description
1	033070-000	2	SHELF ASSEMBLY, 15
2	033096-000	1	SHELF ASSEMBLY, 15

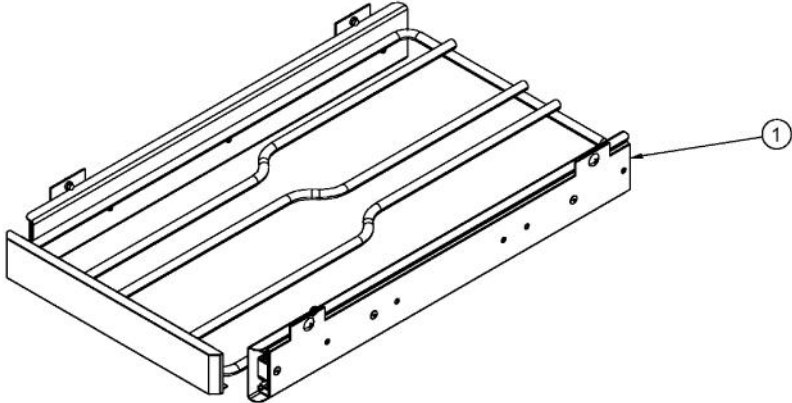
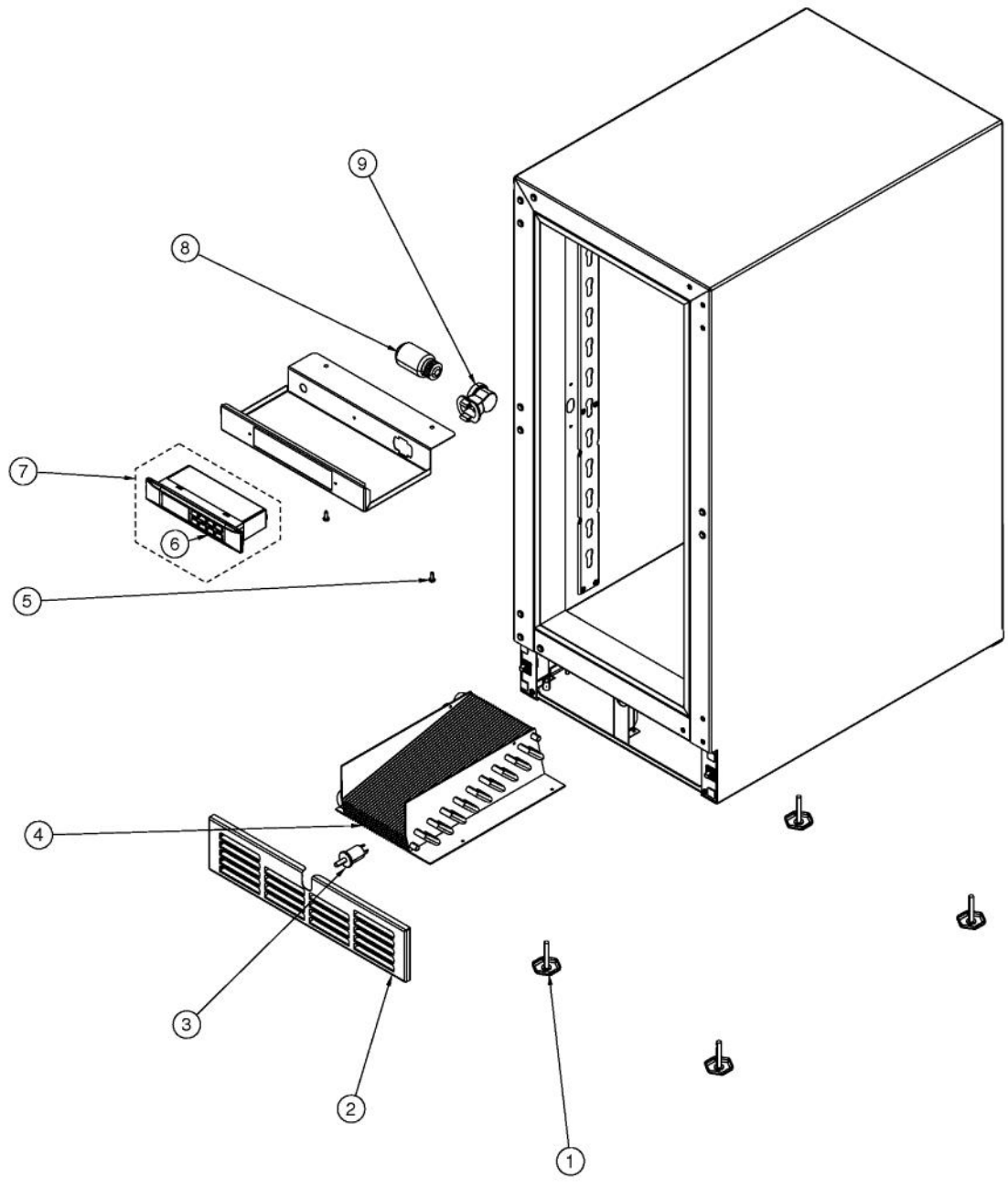

Ref #	Part Number	Qty.	Description
1	033033-000	4	LEVELLING LEG
2	033073-000	1	GRILLE ASSEMBLY, 15
3	033040-000	1	DOOR SWITCH
4	033074-000	1	CONDENSER
5	033024-000	2	FASTENER, CONTROL MOUNTING
6	033023-000	1	CONTROLLER FACE PLATE
7	033050-000	1	CONTROLLER ASSY
8	033026-000	1	LIGHT BULB
9	033027-000	1	LIGHT SOCKET
NI	033028-000	1	HARNESS, CONTROLLER
NI	033039-000	1	HARNESS, MACHINE COMPARTMENT
NI	033025-000	1	SENSOR

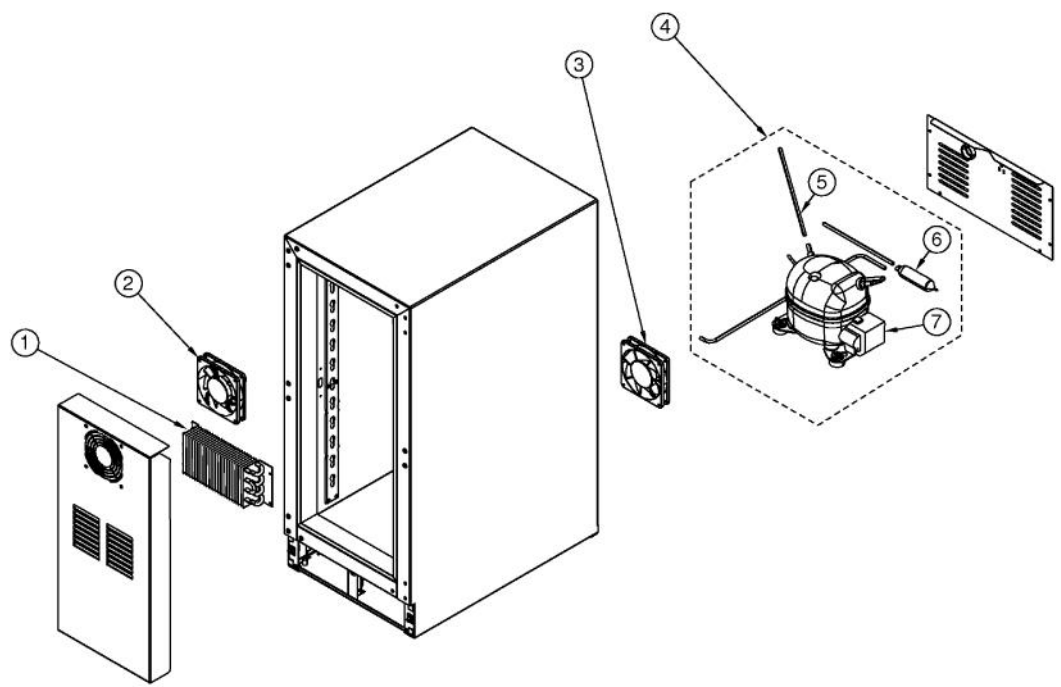

Ref #	Part Number	Qty.	Description
1	033072-000	1	EVAP ASSEMBLY
2	033030-000	1	FAN MOTOR
3	033030-000	1	FAN MOTOR
4	033034-000	1	COMPRESSOR KIT
5	033037-000	2	PROCESS TUBE
6	033035-000	1	DRIER
7	033036-000	1	COMP. START COMPONENTS
NI	033031-000	1	HARNESS, FAN MOTOR
NI	033042-000	1	POWER CORD

VIKING UC PRODUCT

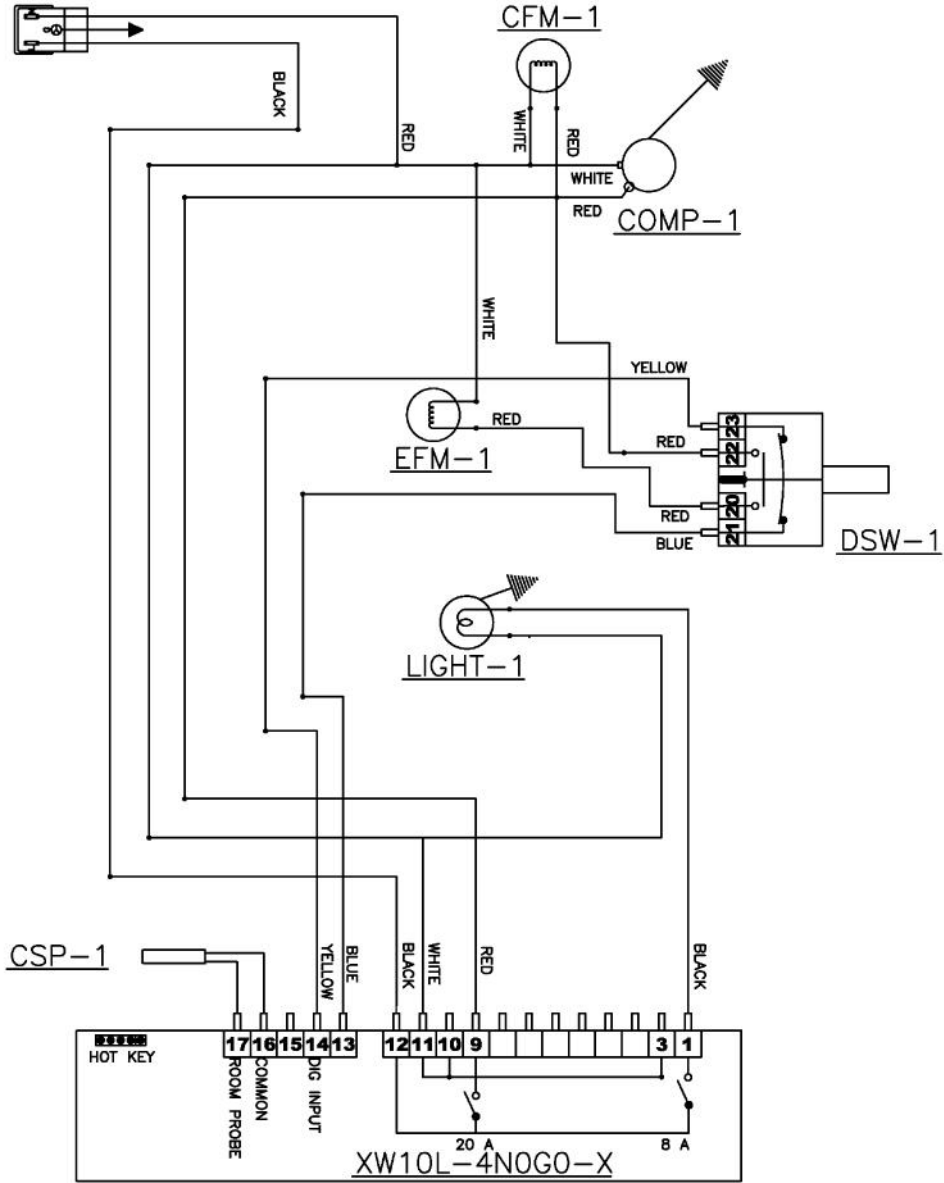

- XW10L--REFRIGERATION SYSTEM CONTROLLER
- DSW-1--LIGHT AND EVAP FAN MOTOR DOOR SWITCH
- LIGHT 1--COMPARTMENT LIGHT
- EFM 1--EVAPORATOR FAN MOTOR
- CSP-1--REFRIGERATED COMPARTMENT 1 SENSOR PROBE
- CFM-1--CONDENSER FAN MOTOR

Ref #	Part Number	Qty.	Description
-------	-------------	------	-------------
