

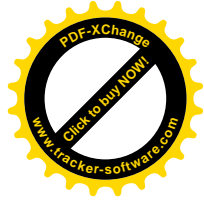

FDW300





CHA	IS	
DOOR ASSY		
YUB INTERIOR		3
FDW101-102-300 OUTER DOOR PARTS		4
Appendix A:Pages Index		A
Appendix B:Parts Index		B

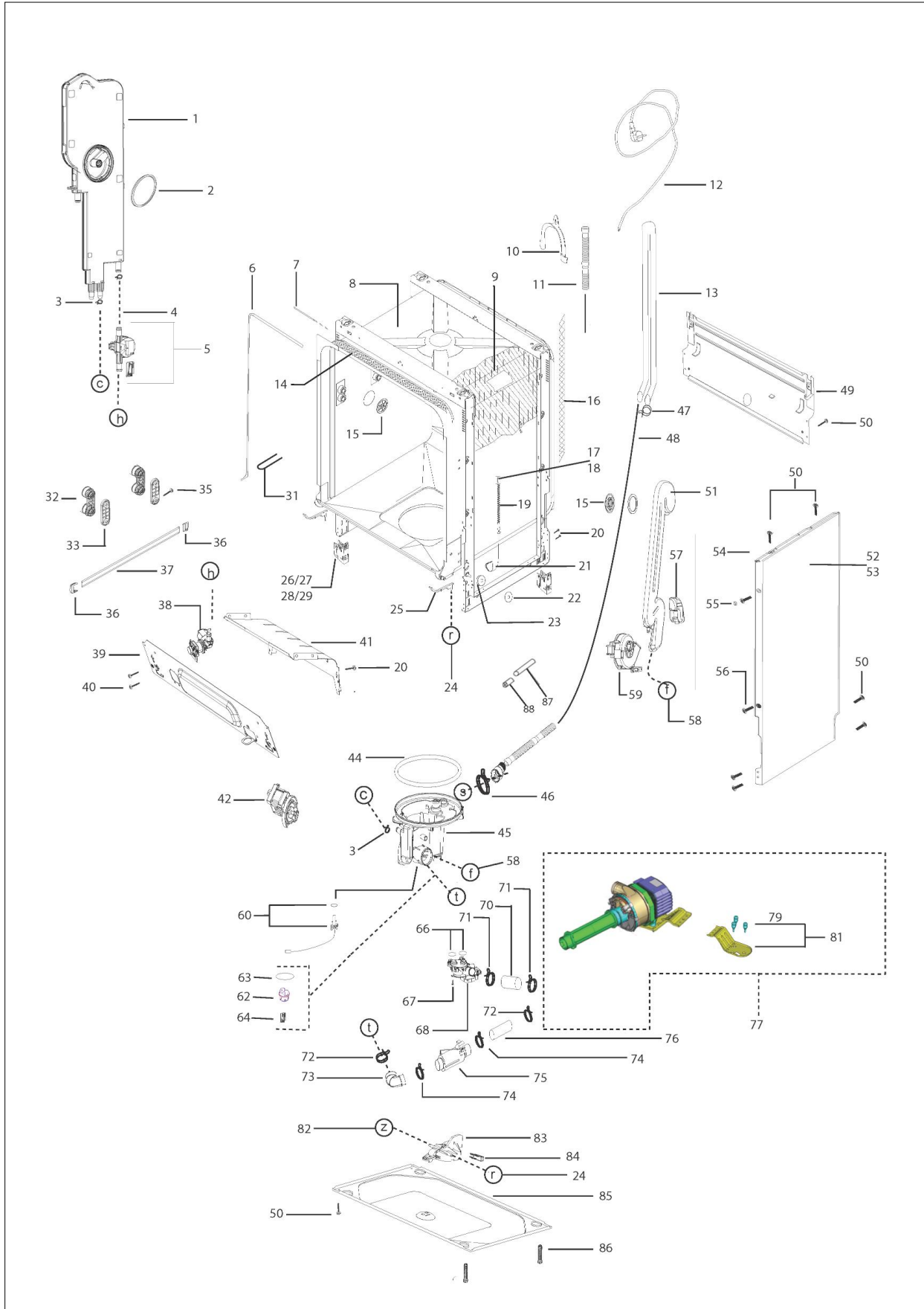

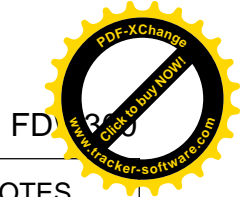

FD

Item	Part No.	Name	Qty	Uom	NOTES
1	050775-000	REGENERATION UNIT	1	EA	
2	039910-000	AIR FUNNEL GASKET	1	EA	
Comments for Part Num. 039910-000					
bradleysapplianceservice@shaw.ca on Feb 28, 2017					
SUBS TO: 039910-000 AIR FUNNEL GASKET					
3	039958-000	HOSE CLAMP (Ø 15.88)	3	EA	
4	039866-000	HOSE BETWEEN COUNTER AND REGENERATION U.	1	EA	
5	050887-000	COUNTER GROUP	1	EA	
6	039769-000	DOOR SEALING GASKET	1	EA	
7	039904-000	NOISE ISOLATION FOR TUB RAL 7037.	1	EA	
8	050776-000	STRUCTURE GROUP	1	EA	
9	050777-000	INNER TUB ISOLATION	1	EA	
10	040591-000	Drain Hose Holder	1	EA	
11	039726-000	DRAIN HOSE	1	EA	
Comments for Part Num. 039726-000					
bradleysapplianceservice@shaw.ca on Jul 15, 2016					
IF LONG EXTERIOR DRAIN HOSE IS REQUIRED - FROM BACK OF DISHWASHER TO DRAIN OUTLET - ORDER PART NUMBER: 039726-000 DRAIN HOSE					
IF SUMP TO BACK OF UNIT DRAIN HOSE IS REQUIRED - INSIDE OF UNIT - ORDER PART NUMBER: 039725-000 SUMP DRAIN HOSE (16 INCHES LONG)					
Reply by profixappliances@gmail.com on Dec 12, 2017					
Thank you for the clarification!					
12	039949-000	MAIN PLUG EURO 120 V CANADA	1	EA	
13	039792-000	COLUMN ASSY	1	EA	
14	039923-000	DOOR LOCK COTTON FLEECE	1	EA	
15	050778-000	air funnel cup	2	EA	
16	039922-000	REAR FRAME COTTON FLEECE	1	EA	
17	039763-000	DOOR ADJUSTMENT GROUP-LEFT	1	EA	
18	039764-000	DOOR ADJUSTMENT GROUP-RIGHT	1	EA	

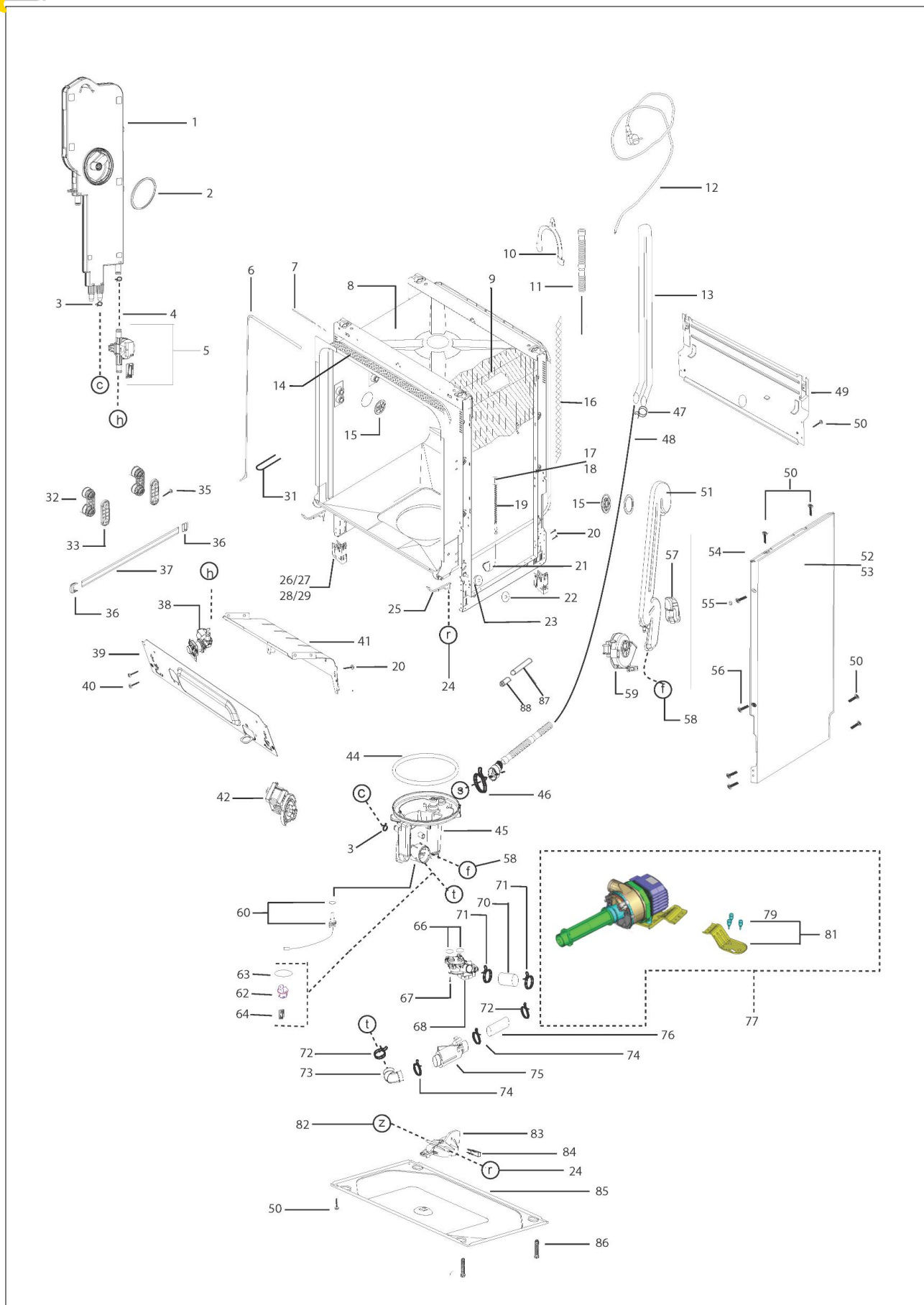

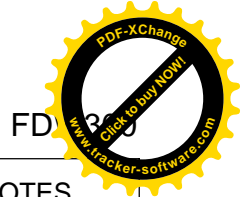

FD

Item	Part No.	Name	Qty	Uom	NOTES
19	039895-000	HINGE SPRING	2	EA	
20	039917-000	BOLT M4X8 D3731 D3421	25	EA	
21	039894-000	HINGE ROPE GROUP	2	EA	
22	039883-000	WASHER	2	EA	
23	039893-000	HINGE WHEEL	2	EA	
24	039872-000	HOSE	1	EA	
25	039921-000	OVERFLOW SIPHON	2	EA	
26	050779-000	FOOT GROUP-ADJUSTABLE- RIGHT-FRONT	1	EA	
27	039941-000	FOOT GROUP-ADJUSTABLE- RIGHT-BACK	1	EA	
28	039942-000	FOOT GROUP-ADJUSTABLE- LEFT-FRONT	1	EA	
29	039943-000	Rear feet Adjustable LEFT BACK	1	EA	
31	039901-000	DOOR LOCK HOOK	1	EA	
32	050780-000	GRD BALL BEARING ROLLER GROUP	4	EA	
33	039777-000	RAIL WHEEL HOLDER	4	EA	
35	050781-000	SCREW	8	EA	
36	050782-000	rail cap front back	4	EA	
37	039887-000	RAIL	2	EA	
38	039756-000	WATER INLET VALVE	1	EA	
39	039773-000	KICK PLATE SHEET	1	EA	
40	039761-000	SCREW	2	EA	
41	039885-000	LOWER SUPPORT - FRONT	1	EA	
42	039758-000	DRAIN PUMP GROUP	1	EA	
44	039722-000	SUMP GASKET	1	EA	
45	050783-000	SUMP GROUP	1	EA	
46	039954-000	Hose Clamp	1	EA	
47	039952-000	HOSE CLAMP (Ø 28_7)	2	EA	
48	039725-000	DRAIN HOSE	1	EA	

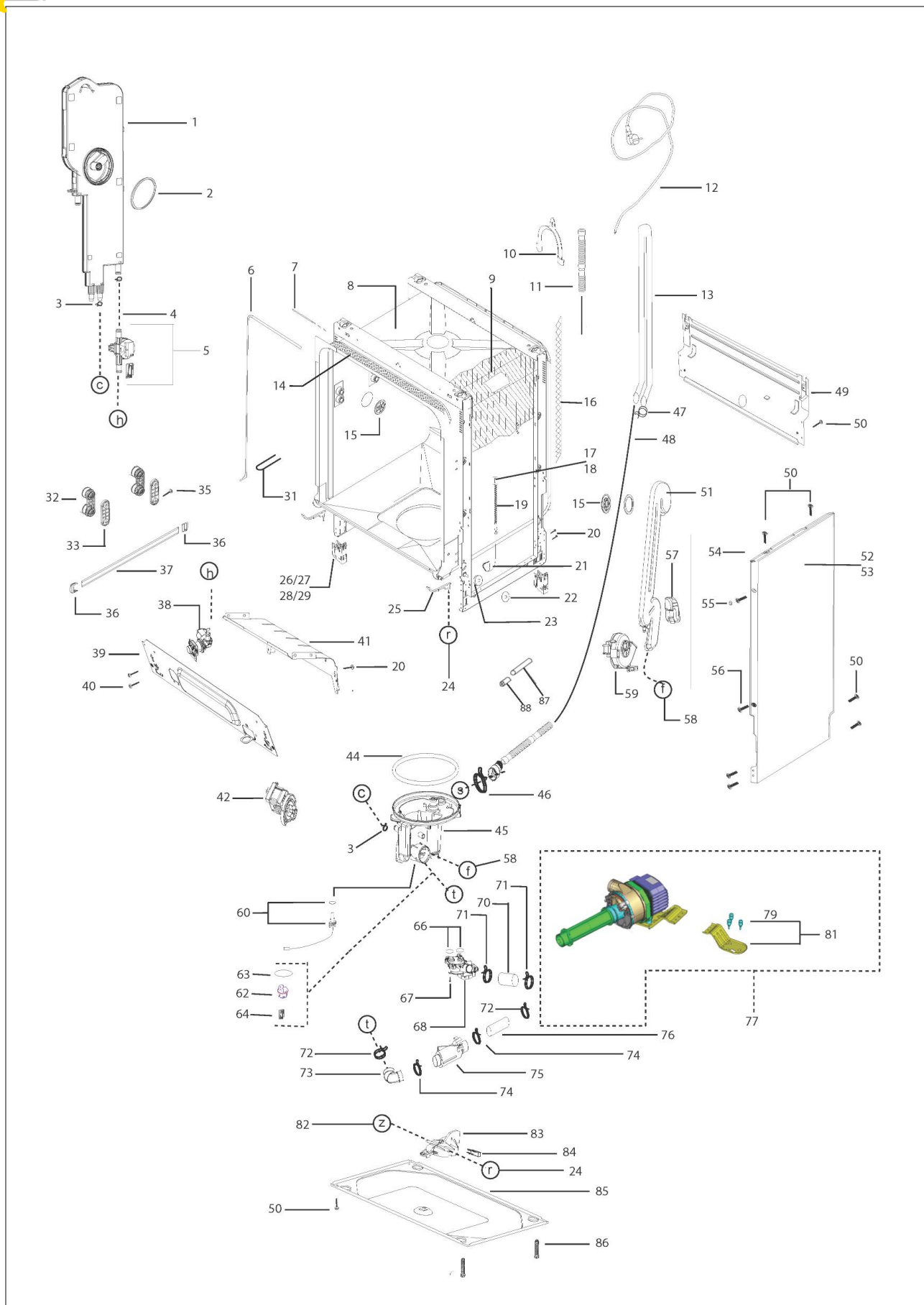

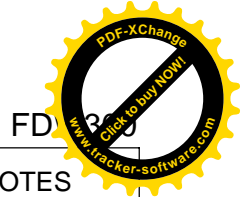
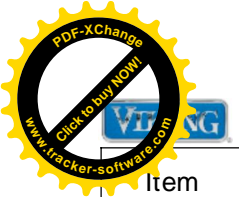

FD

Item	Part No.	Name	Qty	Uom	NOTES
Comments for Part Num. 039725-000					
profixappliances@gmail.com on Dec 12, 2017					
Per Bradleysappliance service: IF LONG EXTERIOR DRAIN HOSE IS REQUIRED - FROM BACK OF DISHWASHER TO DRAIN OUTLET - ORDER PART NUMBER: 039726-000 DRAIN HOSE					
IF SUMP TO BACK OF UNIT DRAIN HOSE IS REQUIRED - INSIDE OF UNIT - ORDER PART NUMBER: 039725-000 SUMP DRAIN HOSE (16 INCHES LONG)					
49	050891-000	REAR BOTTOM SUPPORT	1	EA	
50	039876-000	SCREW	22	EA	
51	050784-000	FAN SUCTION PIPE	1	EA	
52	050785-000	SIDE PANEL-LEFT	1	EA	
53	050795-000	SIDE PANEL-RIGHT	1	EA	
54	039888-000	NOISE ISOLATION	2	EA	
55	039905-000	SCREW CAP SIDE WALLS	4	EA	
56	039876-000	SCREW	4	EA	
57	050796-000	FAN OUTLET PIPE	1	EA	
58	050797-000	HOSE BETWEEN FAN AND SUMP	2	EA	
59	050179-000	FAN MOTOR GROUP	1	EA	Not available online / Call for pricing and availability
60	039933-000	NTC GROUP	1	EA	
62	039900-000	TURBIDITY FRAME	1	EA	
63	039868-000	O-RING (TURBIDITY)	1	EA	
64	039950-000	TURBIDITY CARD AND LED HOLDER GR	1	EA	
66	039902-000	O-RING (FLOW DIVERTER)	2	EA	
67	039880-000	SCREW	4	EA	
68	039863-000	THREE WAY VALVE	1	EA	
70	050798-000	HOSE	1	EA	
71	039957-000	HOSE CLAMP	1	EA	
72	050799-000	HOSE CLAMP	1	EA	
73	039723-000	HOSE BETWEEN SUMP AND HEATER	1	EA	
74	050800-000	SUMP CLAMP SCREW TYPE.	1	EA	
75	039757-000	FLOW THROUGH HEATER	1	EA	

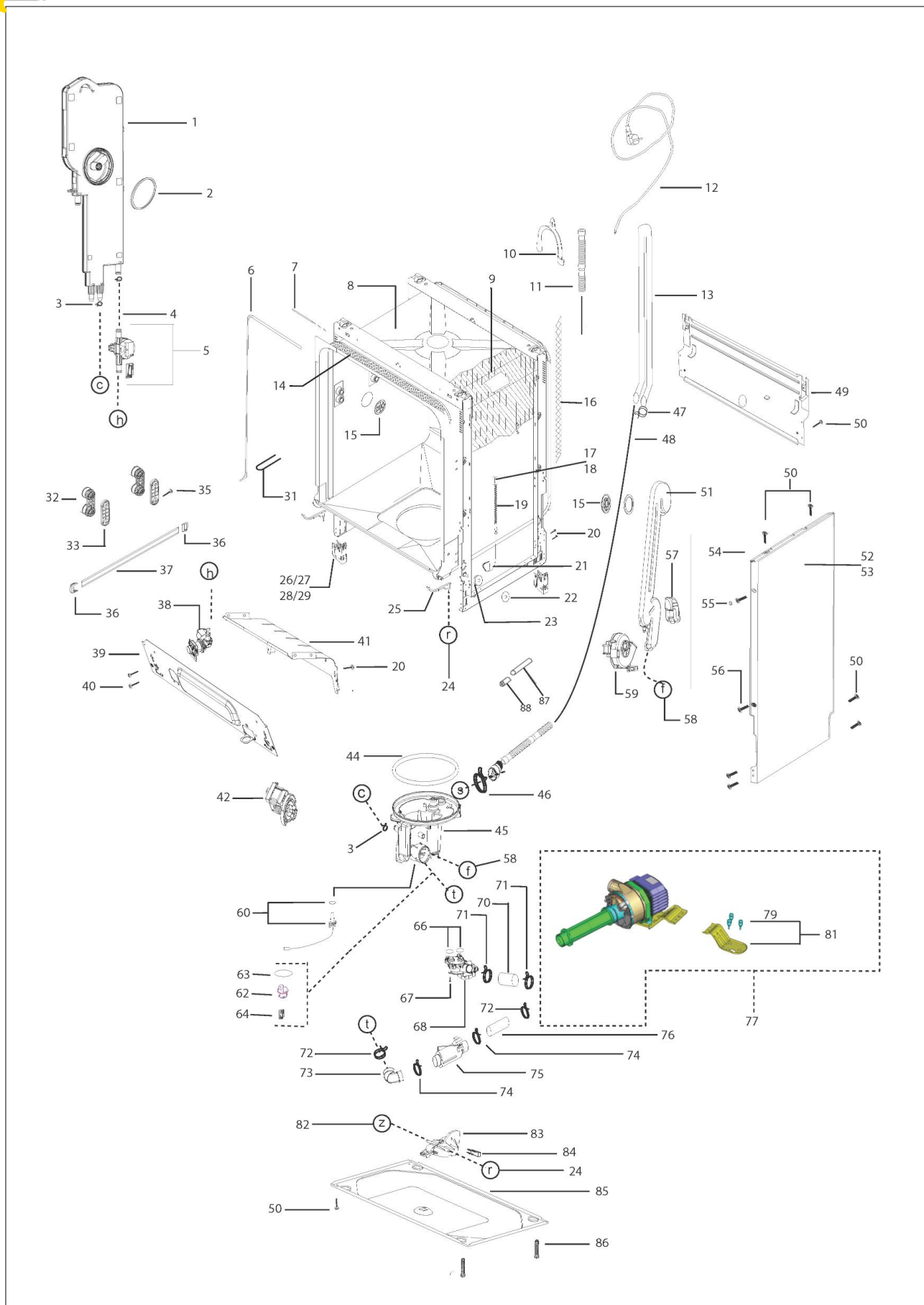

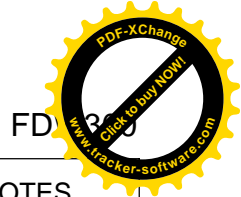

FD

Item	Part No.	Name	Qty	Uom	NOTES
76	050801-000	PUMP INLET HOSE	1	EA	Not available online / Call for pricing and availability
77	050802-000	MOTOR_SPRAY PUMP	1	EA	
79	050803-000	CIRCULATION PUMP DAMPENING RUBBER	3	EA	Not available online / Call for pricing and availability
81	050804-000	MOTOR BRACKET GROUP	1	EA	Not available online / Call for pricing and availability
82	039873-000	HOSE	1	EA	
83	039934-000	OVERFLOW FLOAT GROUP	1	EA	
84	039913-000	MICRO SWITCH	1	EA	
85	039886-000	BOTTOM TRAY	1	EA	
86	039889-000	FOOT GROUP-ADJUSTABLE	4	EA	
87	039937-000	REAR ADJUSTABLE FOOT CONNECTION PART	2	EA	
88	039938-000	REAR ADJUSTABLE DOOR CONNECTION PART	2	EA	
NI	057530-000	ACCESSORIES	1	EA	
Not Shown	NOTE	INSTALL HARDWARE		EA	
NI	064528-000	LEFT MOUNTING BRACKET	1	EA	
Not Shown	NOTE	TO SECURE UNIT TO CABINET		EA	
NI	064529-000	RIGHT MOUNTING BRACKET	1	EA	
Not Shown	NOTE	TO SECURE UNIT TO CABINET		EA	

OR ASSY

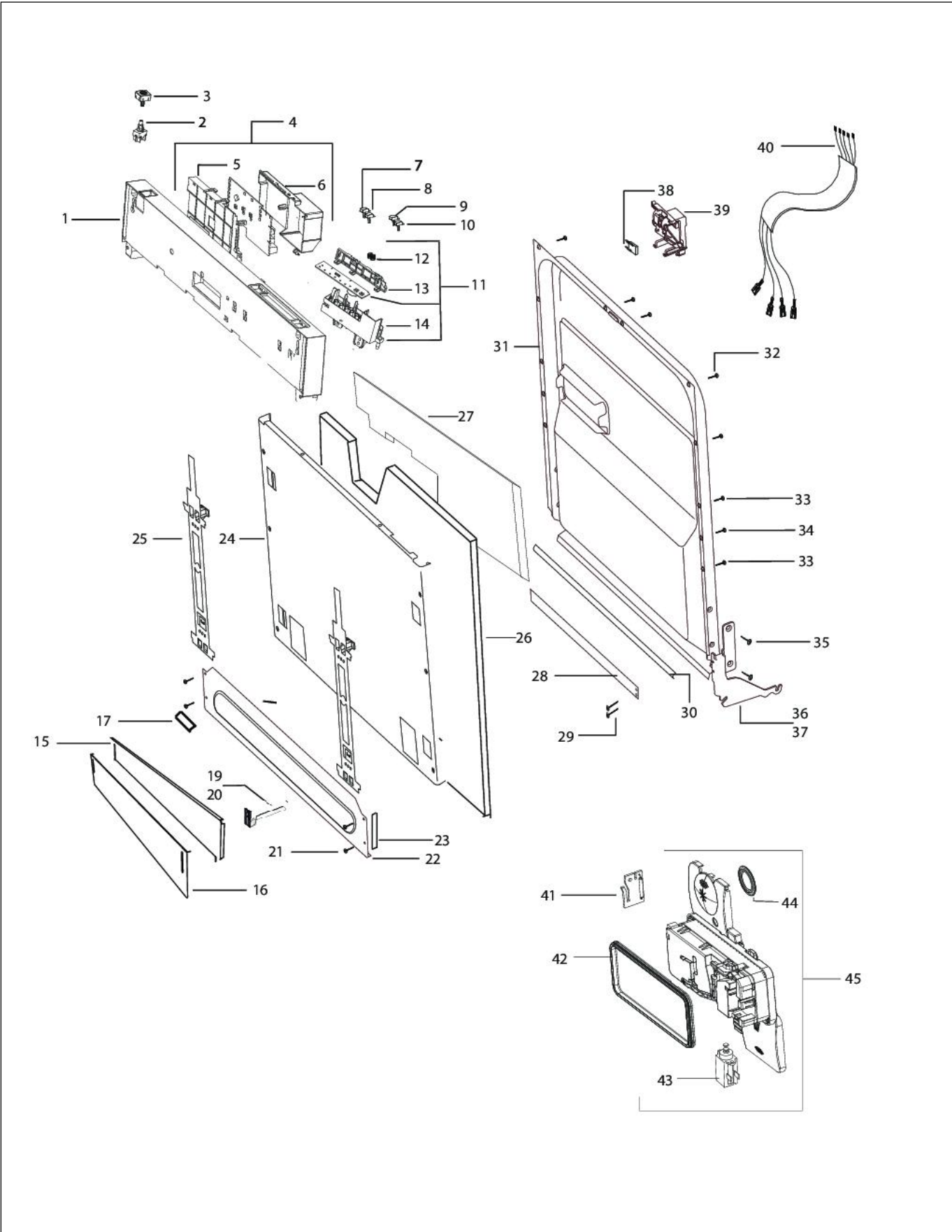

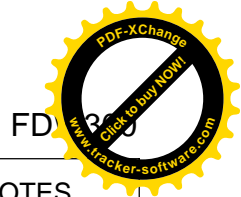

FD

Item	Part No.	Name	Qty	Uom	NOTES
1	050823-000	PANEL GROUP	1	EA	
2	050824-000	rold on off switch	1	EA	
3	050825-000	ANKASTRE ON OFF TUSU STROKE 2.5MM	1	EA	
4	039837-000	ELECTRONIC CARD GROUP	1	EA	
5	039798-000	CARD HOLDER-FRONT	1	EA	
6	039800-000	CARD HOLDER-BACK	1	EA	
7	039852-000	CLAD F5 START STOP BUTTON PRINTED -BLACK	1	EA	
8	039851-000	F5 PRG. SECIM TUSU BASKILI - BLACK	1	EA	
9	050826-000	CLAD F5 HALF LOAD BUTOON PRINTED - BLACK	1	EA	
10	039854-000	CLAD F5 PROGRAM DELAY BUTTON - BLACK	1	EA	
11	059356-000	DISPLAY CARD GROUP	1	EA	
12	039795-000	BUTTON GASKET	2	EA	
13	039797-000	DISPLAY CARD HOLDER-BACK	1	EA	
14	039796-000	DISPLAY CARD HOLDER- FRONT	1	EA	
15	039926-000	KICK PLATE SHEET	1	EA	
16	060210-000	KICK PLATE SHEET	1	EA	
17	039928-000	KICK PLATE ADJUSTING LOCKET	1	EA	
19	039924-000	PLINTH ADJUSTMENT SHEET LEFT	1	EA	
20	039925-000	PLINTH ADJUSTMENT SHEET RIGHT	1	EA	
21	039876-000	SCREW	22	EA	
22	039773-000	KICK PLATE SHEET	1	EA	
23	039888-000	NOISE ISOLATION	2	EA	
24	039772-000	B_I OUTER DOOR TALL TUB	1	EA	
25	050828-000	BOARD CONNECTION PART	1	EA	
26	039903-000	DOOR INSULATION	1	EA	
27	039932-000	DOOR INSULATION	1	EA	
28	039935-000	HINGE ARM SUPPORT	1	EA	
29	039917-000	BOLT M4X8 D3731 D3421	25	EA	

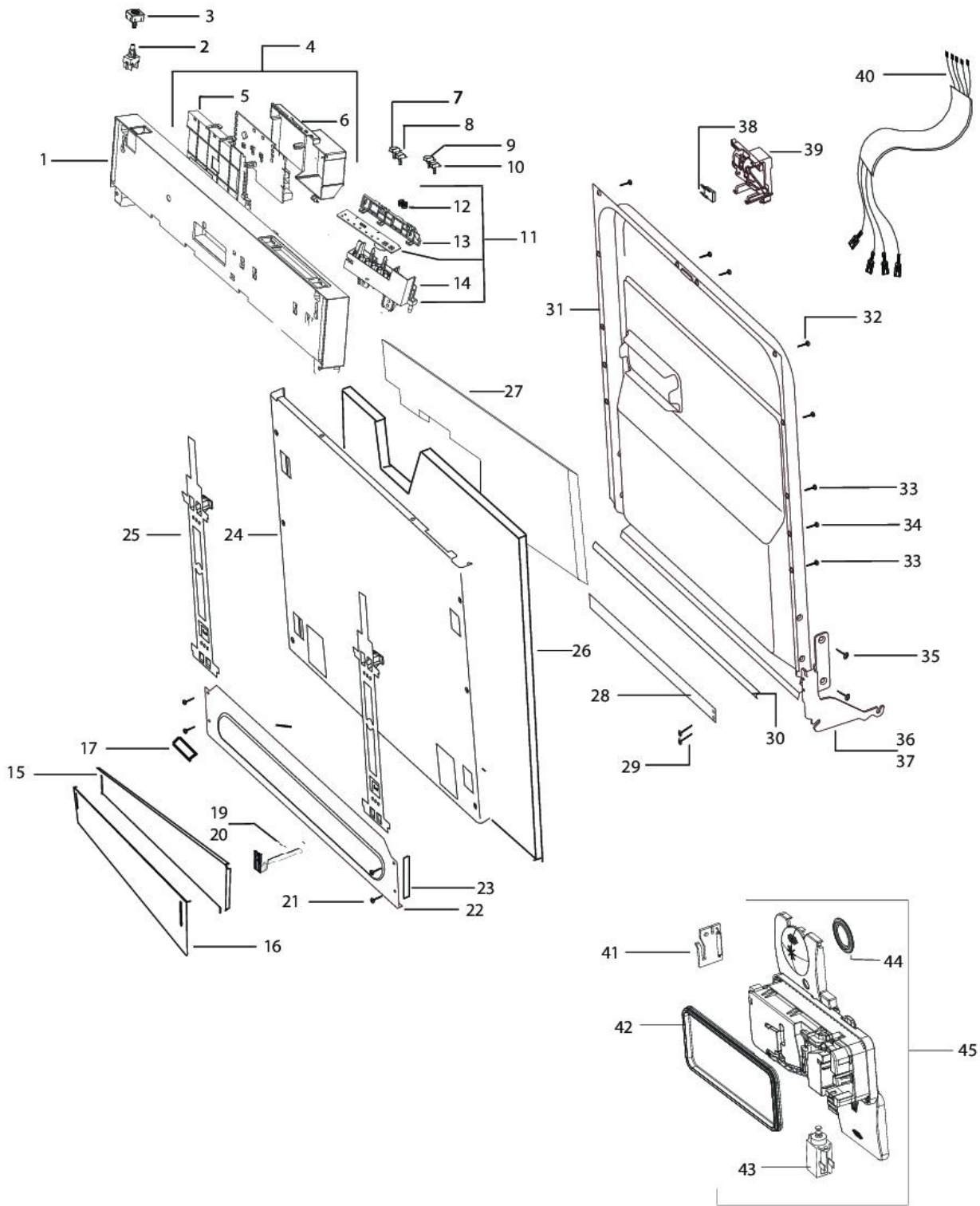

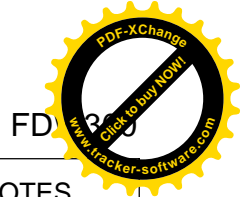

FD

Item	Part No.	Name	Qty	Uom	NOTES
30	039908-000	DOOR SEALING GASKET	1	EA	
31	039720-000	INNER DOOR GR	1	EA	
32	039914-000	SCREW	6	EA	
33	039916-000	SCREW	4	EA	
34	039912-000	INNER DOOR STOPER	2	EA	
35	039877-000	SCREW	4	EA	
36	039739-000	HINGE ARM RIGHT	1	EA	
37	039738-000	HINGE ARM LEFT	1	EA	
38	059878-000	NEW DOOR SWITCH	1	EA	
39	057515-000	DOOR LOCK GROUP	1	EA	
40	050830-000	F5 CABLE HARNESS UL	1	EA	
41	050831-000	RINSE AID GLASS	1	EA	
42	039714-000	DETERGENT DISPENSER GASKET	1	EA	
43	039882-000	THERMOACTUATOR D3731 D3421	1	EA	
44	039713-000	RINSE AID GASKET	1	EA	
45	039715-000	DETERGENT DISPENSER GROUP	1	EA	

CD INTERIOR

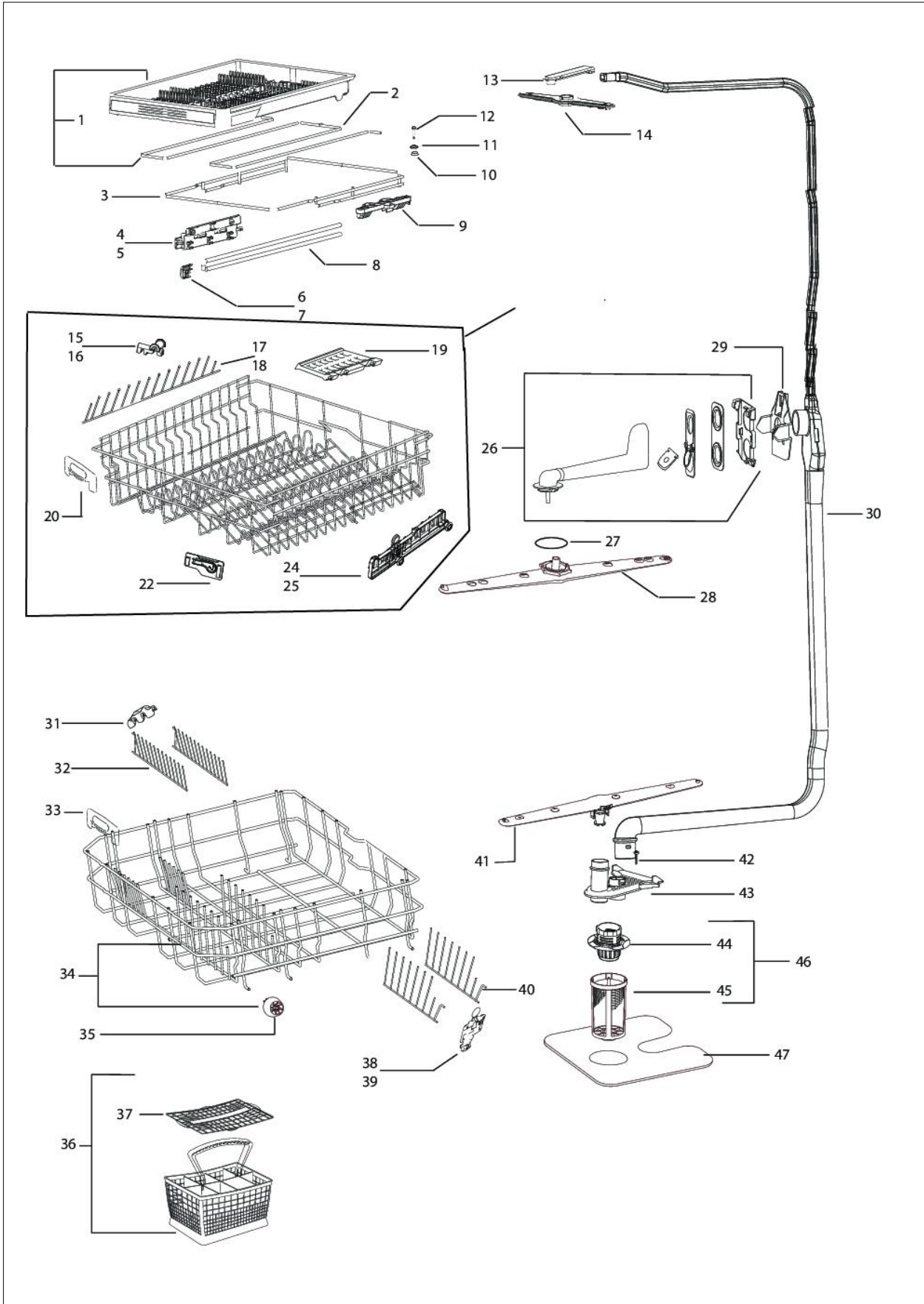

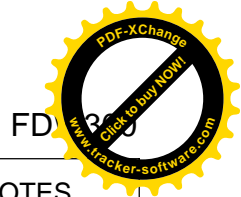

FD

Item	Part No.	Name	Qty	Uom	NOTES
1	050808-000	UPPER TRAY GROUP	1	EA	
2	050809-000	UPPER TRAY FRAME WIRE	1	EA	
3	050810-000	UPPER TRAY HOLDER	1	EA	
4	050811-000	UPPER TRAY DRAWER HOLDER-LEFT	1	EA	
5	050812-000	UPPER TRAY DRAWER HOLDER-RIGHT	1	EA	
6	050813-000	UPPER TRAY RAIL CAP-RIGHT	1	EA	
7	050814-000	UPPER TRAY RAIL CAP-LEFT	1	EA	
8	050815-000	CEILING RAIL	2	EA	
9	050816-000	UPPER TRAY RAIL HOLDER	2	EA	
10	050817-000	CONNECTING WASHER	4	EA	
11	039868-000	O-RING (TURBIDITY)	4	EA	
12	039880-000	SCREW	4	EA	
13	039847-000	CEILING SPRAY ARM FEED PIPE	1	EA	
14	039841-000	CEILING SPRAY GROUP	1	EA	
15	039861-000	UPPER BASKET CLIPS	11	EA	
16	039783-000	FOLDING PART CLIPS RIGHT	1	EA	
17	039779-000	UPPER BASKET SUPPORT WIRE	1	EA	
18	050819-000	UPPER BASKET SUPPORT WIRE	1	EA	
19	039785-000	SHELF GROUP	4	EA	
20	039846-000	UPPER BASKET HANDLE GR	1	EA	
22	050820-000	GRD FOLDING PART	1	EA	
24	039786-000	UPPER BASKET MECHANISM- LEFT	1	EA	
25	039787-000	UPPER BASKET MECHANISM- RIGHT	1	EA	
26	039862-000	UPPER SPRAY ARM FEED PIPE	1	EA	
27	039870-000	GASKET	1	EA	
28	039892-000	UPPER SPRAY ARM GROUP	1	EA	
29	050882-000	UPPER SPRAY ARM GUIDE ADJUSTABLE BASKET	1	EA	
30	039840-000	WATER SUPPLY TUBE GROUP	1	EA	

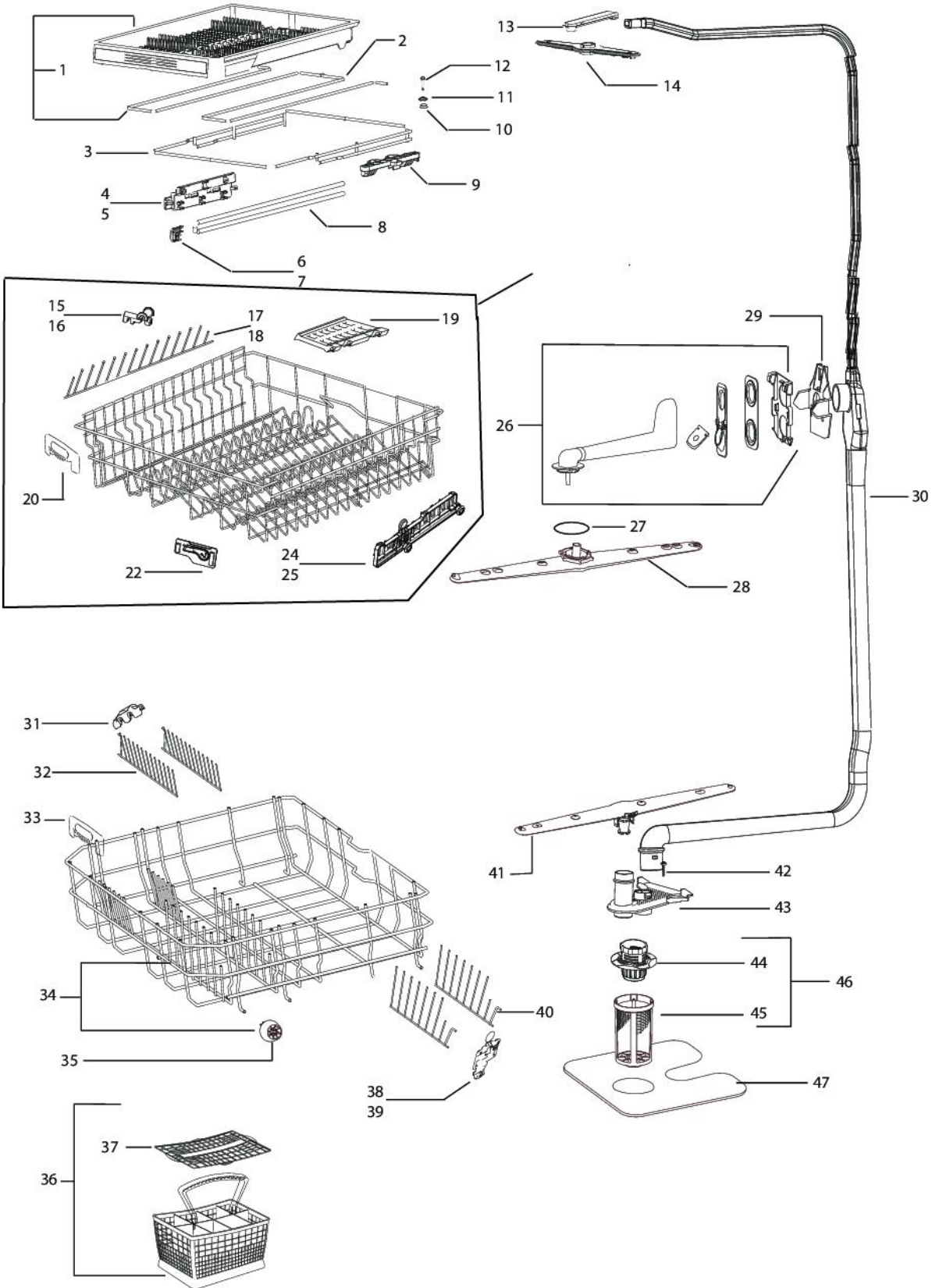

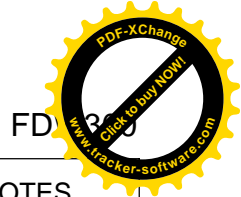

FD

Item	Part No.	Name	Qty	Uom	NOTES
31	050821-000	LOWER BASKET CLIPS	3	EA	
32	039789-000	PLATE HOLDER-RIGHT	2	EA	
33	050883-000	LOWER BASKET HANDLE	1	EA	
34	050822-000	LOWER BASKET GROUP	1	EA	
35	050884-000	GRD LOWER BASKET SANTOPRENE WHEEL GROUP	8	EA	
36	039790-000	CUTLERY BASKET GROUP	1	EA	
37	039791-000	CUTLERY BASKET SEPARATOR	2	EA	
38	050884-000	GRD LOWER BASKET SANTOPRENE WHEEL GROUP	8	EA	
39	039857-000	LOWER BASKET FOLDING PART	1	EA	
40	039788-000	PLATE HOLDER-LEFT	2	EA	
41	039896-000	LOWER SPRAY ARM GROUP	1	EA	
42	039945-000	SCREW	5	EA	
43	039734-000	FILTER SUPPORT GROUP	1	EA	
44	039729-000	COARSE FILTER	1	EA	
45	039728-000	MICRO FILTER GROUP	1	EA	
46	039733-000	FILTER GROUP	1	EA	
47	039730-000	METAL FILTER GROUP	1	EA	
48	060241-000	UPPER RACK GR. RAL 7037	1	EA	

W101-102-300 OUTER DOOR PARTS



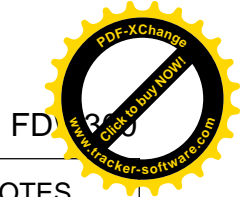

FD

Item	Part No.	Name	Qty	Uom	NOTES
1	036189-000	OUTER DOOR ASSY- PART NLA	1	EA	
2	036188-000	DOOR SKIN	1	EA	Not available online / Call for pricing and availability
3	034825-000	HANDLE, DW	1	EA	
4	026965-000	END CAP, ASM, DOOR HANDLE	2	EA	
5	PD010019	BLT-1/4-20X3/8"HEX WASHER SERATED	4	EA	
6	PE010016	LOGO (ALL RANGES) *BK/CHR 307997W	1	EA	
7	PD030008	HEX NUT	2	EA	
8	PD030178	CLIP, DOOR SKIN LOCATOR	2	EA	
NI	PB870209	SOUND ABSORBER, DOOR	1	EA	

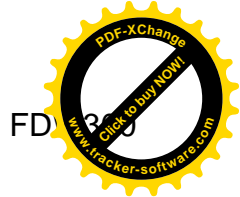
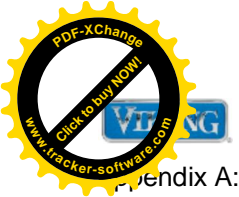

Appendix A:Pages Index

CHASSIS	1
DOOR ASSY	2
FDW101-102-300 OUTER DOOR PARTS	4
TUB INTERIOR	3

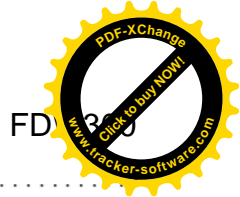
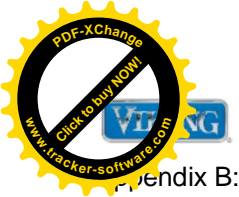

FD

Appendix B: Parts Index

026965-000	4	039796-000	2
034825-000	4	039797-000	2
036188-000	4	039798-000	2
036189-000	4	039800-000	2
039713-000	2	039837-000	2
039714-000	2	039840-000	3
039715-000	2	039841-000	3
039720-000	2	039846-000	3
039722-000	1	039847-000	3
039723-000	1	039851-000	2
039725-000	1	039852-000	2
039726-000	1	039854-000	2
039728-000	3	039857-000	3
039729-000	3	039861-000	3
039730-000	3	039862-000	3
039733-000	3	039863-000	1
039734-000	3	039866-000	1
039738-000	2	039868-000	1, 3
039739-000	2	039870-000	3
039756-000	1	039872-000	1
039757-000	1	039873-000	1
039758-000	1	039876-000	1, 1, 2
039761-000	1	039877-000	2
039763-000	1	039880-000	1, 3
039764-000	1	039882-000	2
039769-000	1	039883-000	1
039772-000	2	039885-000	1
039773-000	1, 2	039886-000	1
039777-000	1	039887-000	1
039779-000	3	039888-000	1, 2
039783-000	3	039889-000	1
039785-000	3	039892-000	3
039786-000	3	039893-000	1
039787-000	3	039894-000	1
039788-000	3	039895-000	1
039789-000	3	039896-000	3
039790-000	3	039900-000	1
039791-000	3	039901-000	1
039792-000	1	039902-000	1
039795-000	2	039903-000	2
		039904-000	1

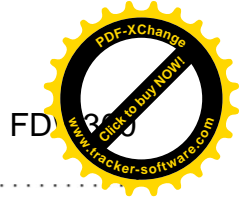
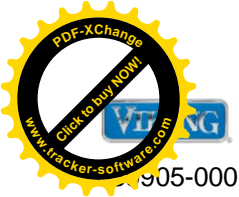

03905-000	1	050783-000	1
039908-000	2	050784-000	1
039910-000	1	050785-000	1
039912-000	2	050795-000	1
039913-000	1	050796-000	1
039914-000	2	050797-000	1
039916-000	2	050798-000	1
039917-000	1, 2	050799-000	1
039921-000	1	050800-000	1
039922-000	1	050801-000	1
039923-000	1	050802-000	1
039924-000	2	050803-000	1
039925-000	2	050804-000	1
039926-000	2	050808-000	3
039928-000	2	050809-000	3
039932-000	2	050810-000	3
039933-000	1	050811-000	3
039934-000	1	050812-000	3
039935-000	2	050813-000	3
039937-000	1	050814-000	3
039938-000	1	050815-000	3
039941-000	1	050816-000	3
039942-000	1	050817-000	3
039943-000	1	050819-000	3
039945-000	3	050820-000	3
039949-000	1	050821-000	3
039950-000	1	050822-000	3
039952-000	1	050823-000	2
039954-000	1	050824-000	2
039957-000	1	050825-000	2
039958-000	1	050826-000	2
040591-000	1	050828-000	2
050179-000	1	050830-000	2
050775-000	1	050831-000	2
050776-000	1	050882-000	3
050777-000	1	050883-000	3
050778-000	1	050884-000	3, 3
050779-000	1	050887-000	1
050780-000	1	050891-000	1
050781-000	1	057515-000	2
050782-000	1	057530-000	1

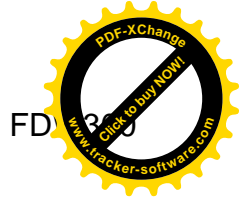
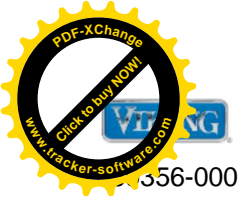

556-000	2
059878-000	2
060210-000	2
060241-000	3
064528-000	1
064529-000	1
PB870209	4
PD010019	4
PD030008	4
PD030178	4
PE010016	4