

VGIC53616BSS

Control View	1
Surface Cooking View	2
Cavity View	3
Decor View	4
Top Interior Cooking View	5
Door View	6
Bottom View	7
Wiring View 1	8
Wiring View 2	9
Appendix A:Pages Index	A
Appendix B:Parts Index	B

Control View

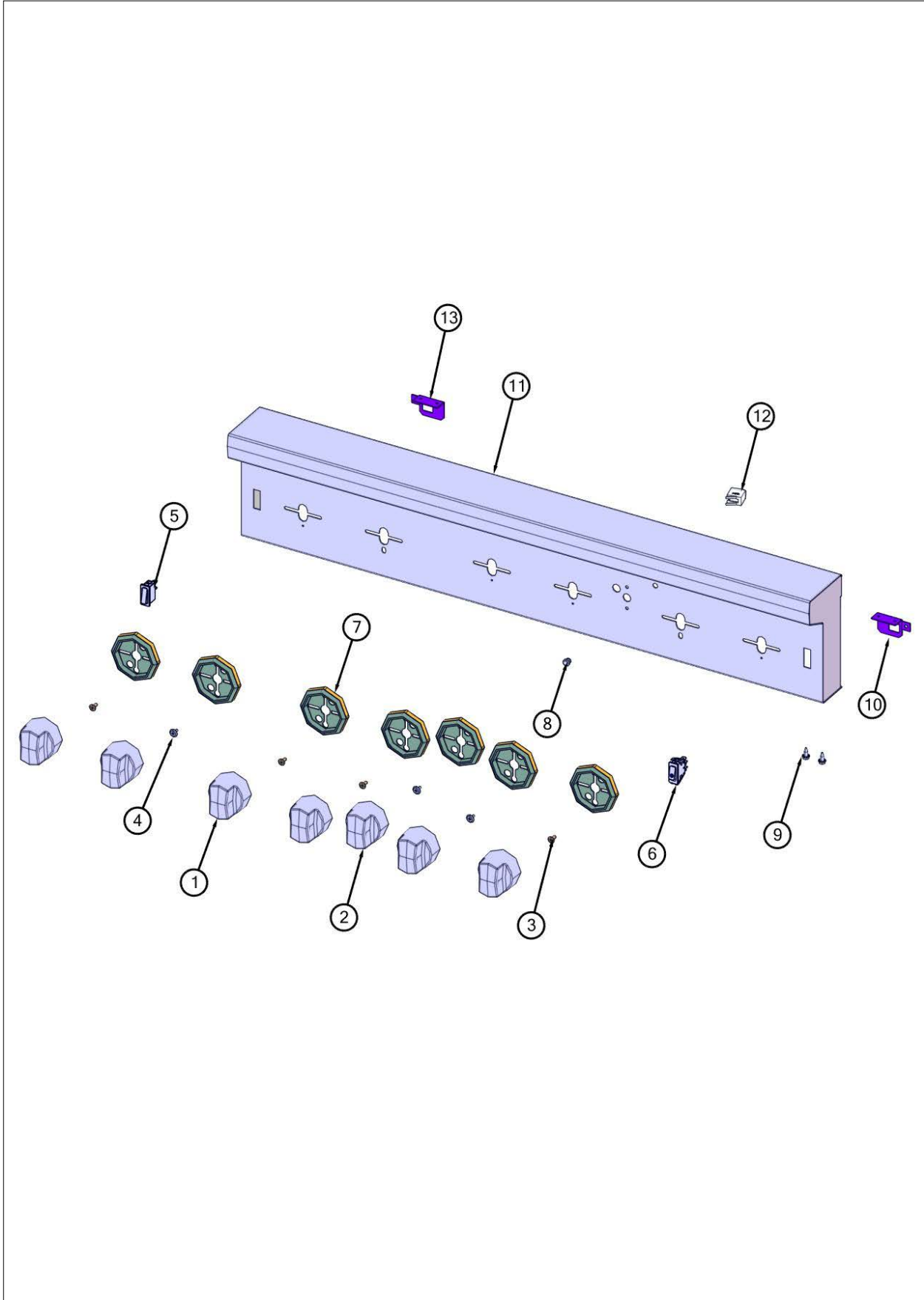



Item	Part No.	Name	Qty	Uom	NOTES
1	035881-000	KNOB, BNR, TOP PRO CR3	6	EA	
2	035891-000	KNOB,OVN,TSTAT, PRO VGCC CR3	1	EA	
3	003083-000	#8-18 x 1/2" PHIL FLAT TOP TRUSS HD AB SCREW	4	EA	
4	pd020073	SRW #10 X 24 X 3/8 WAFER HD TYPE23	3	EA	
5	003719-000	OVEN LIGHT SWITCH, BLACK	1	EA	
6	025098-000	SWITCH, ROCKER, BLK, LIGHTED	1	EA	
7	050172-000	BEZEL, KNOB	7	EA	
8	027968-000	INDICATOR, LIGHT, BLUE	1	EA	
9	003860-000	10-18 x .500 FASTNR,SCR,HXWH,STL,ZPLT	14	EA	
10	024010-000	BRACKET, CAPT, RH	1	EA	
11	058680-2256	PNL, CTRL, ASM, CMPL, VGIC5366B, W/GRAPHICS	1	EA	
12	015170-000	HOUSING, LIGHT, BLUE NEON, 125V	1	EA	
13	024011-000	BRACKET, CAPT, LH	1	EA	

Surface Cooking View

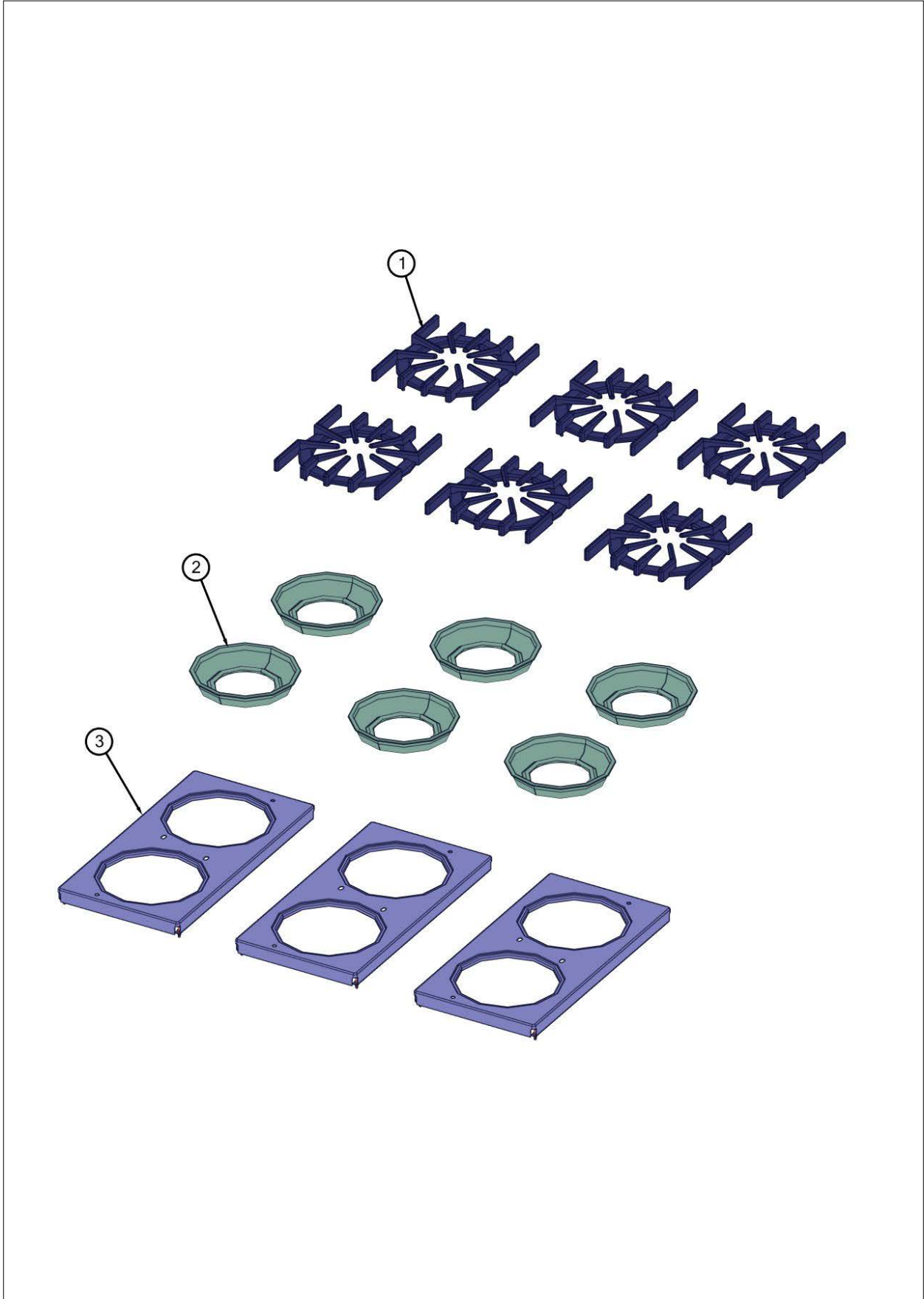



Item	Part No.	Name	Qty	Uom	NOTES
1	PA060037	GRATE BK REPL PA060024 (GEN.#2)	6	EA	
Comments for Part Num. PA060037					
bradleysapplianceservice@shaw.ca on Jun 16, 2020					
SUBS TO: 067027-000 GRATE BK 10 X 11					
2	PA030002BK	BURNER BOWL (VGRT) **BK**	6	EA	
3	E9101115BK	GRATE SUPT *BK* (VGRT)	3	EA	

Cavity View

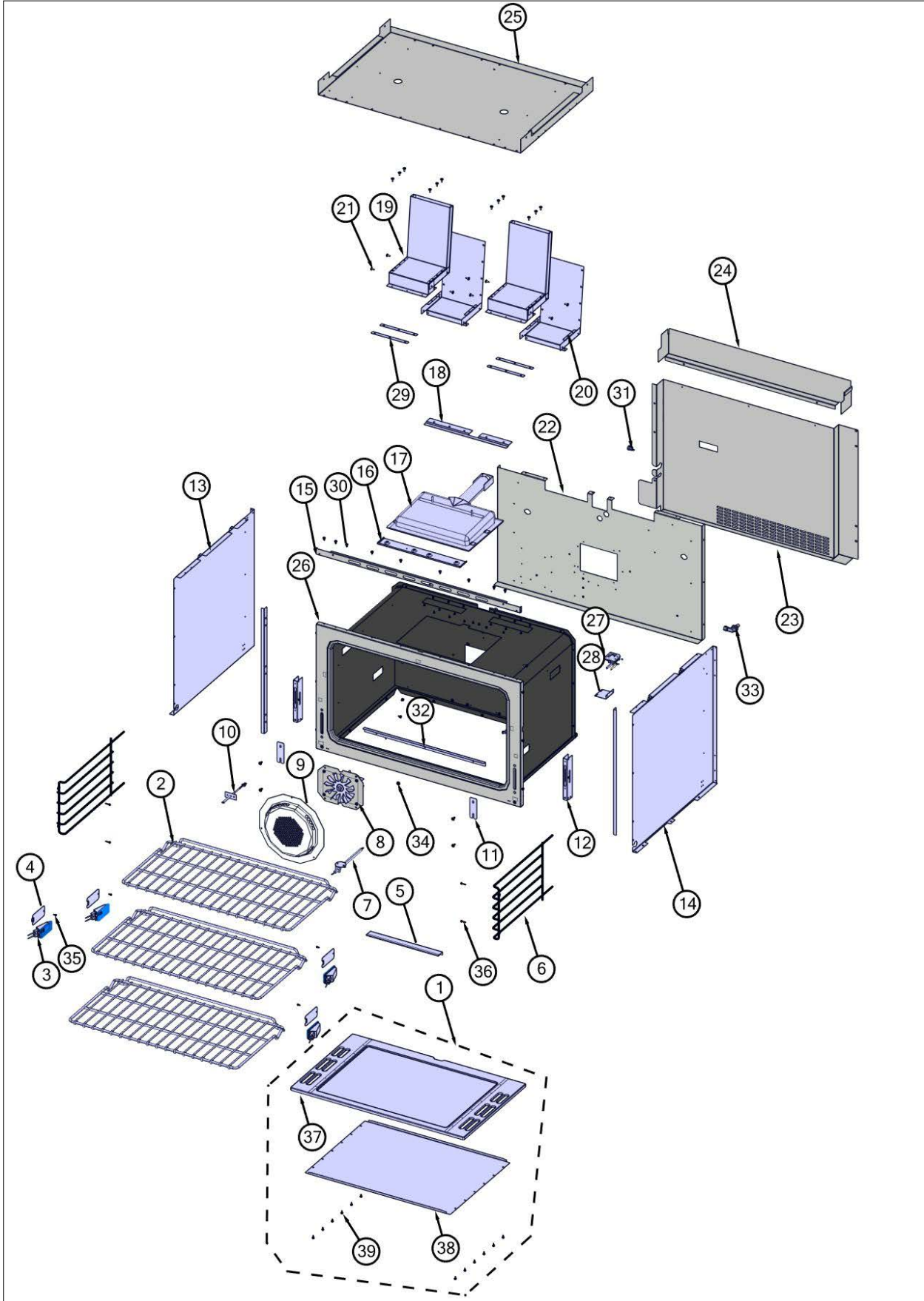



Item	Part No.	Name	Qty	Uom	NOTES
1	066210-000	ASM, BOTTOM, CABITY, OVEN, GAS, 36"	1	EA	
2	040865-000	RACK, PRO, 36"	3	EA	
3	068653-601	LIGHT, 120V/25W, G9, HALOGEN, SIDE (REPLACEMENT BULB USE 074235-000)	2	EA	
4	032858-402	COVER, LT, BK PORCELAIN	2	EA	
5	031445-000	BRACE, OVEN, BOTTOM BACK	1	EA	
6	066225-402	GUIDE, RACK, RH- BK	2	EA	
7	PB040171	BROIL IGNITION ELECTRODE	1	EA	
8	023090-000	MOTOR, CONV ASM	1	EA	
9	021225-402	COVER, CNVN, ASM, BK PORC	1	EA	
10	007008-000	RTD PROBE	1	EA	
11	049718-402	CLIP, RETAINER, HINGE, GLOSS BLACK ENAMEL	2	EA	
12	031679-000	RECEPTACLE, HINGE	2	EA	
13	004482-000	INSULATION, PNL, SIDE, LH	1	EA	
14	004479-000	INSULATION, PNL, SIDE, RH	1	EA	
15	019327-402	TRIM, FR, TOP 36", PORC, BK	1	EA	
16	020409-000	BRACKET, SPRT, FR, I/R BROILER	1	EA	
17	g3001876	IR BURNER ASSY (VGSC/RC) N/S	1	EA	
NI	PB040040	ORIFICE-IR BURNER (VGSC) (NAT #47)	1	EA	
NI	PB040027	IR BUR.SPUD ORF. - #56 LP	1	EA	
18	020412-000	BRACKET, SPRT, REAR, I/R BROILER	1	EA	
19	005944-000	VENT, TOP	2	EA	
20	005945-000	VENT, BOTTOM	2	EA	
21	PD020046	' #8 X 1/2 SCREWS	20	EA	
22	007841-000	BACK INSULATION PANEL, 36"	1	EA	
23	032208-000	PANEL, BACK, OUTER, 36"	1	EA	Not available online / Call for pricing and availability
24	017763-000	BACK, COLLAR 36"	1	EA	

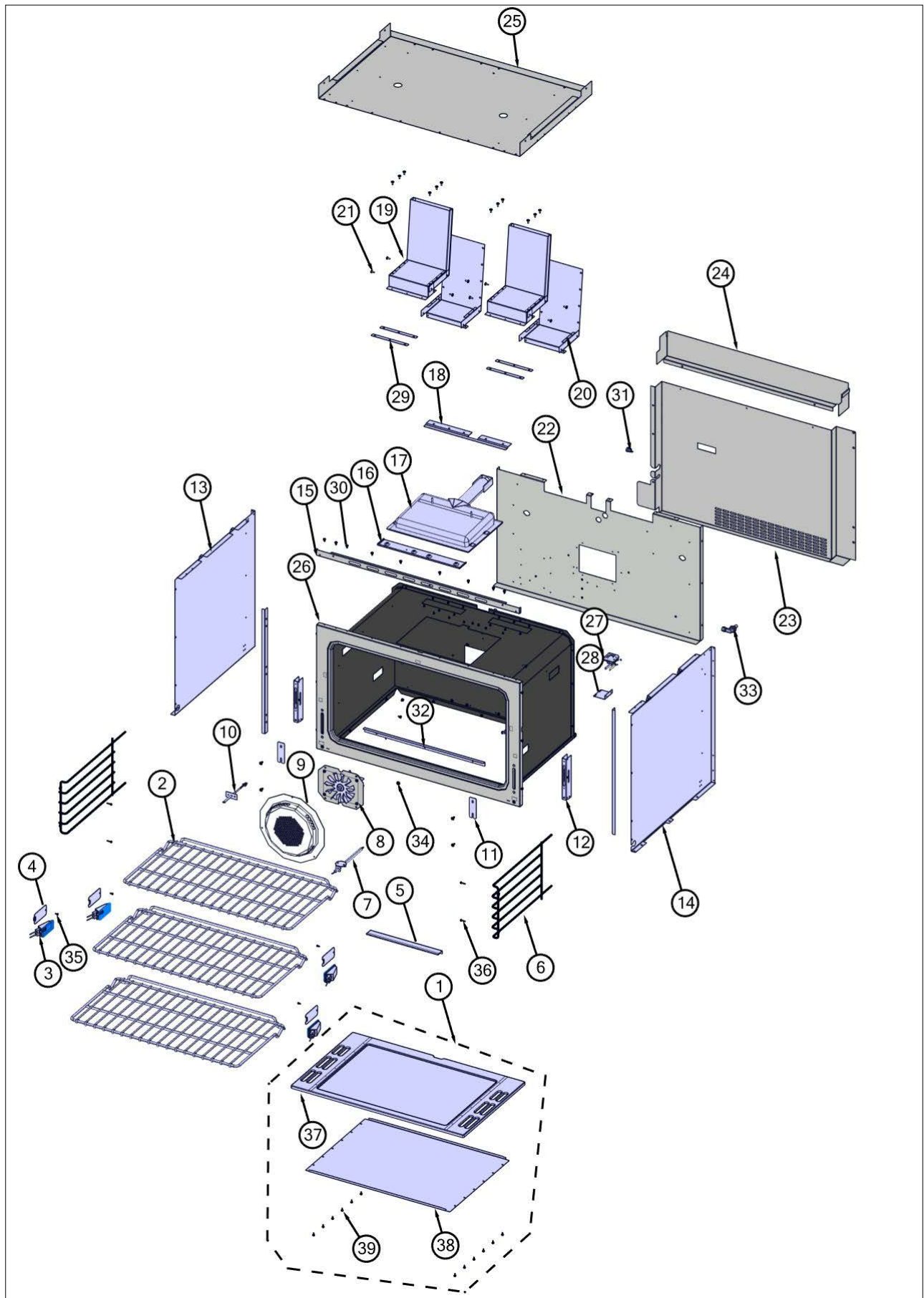



Item	Part No.	Name	Qty	Uom	NOTES
25	015753-000	TOP CABINET, VGIC536	1	EA	Not available online / Call for pricing and availability
26	007849-402	FRONT FRAME WELD ASSY, 36", BK	1	EA	
27	PE050208	DOOR SWITCH	1	EA	
28	A20012649	DOOR SWITCH BRACKET	1	EA	
29	045034-000	BRACKET, WASHER	4	EA	
30	037304-000	FASTENER, PNH, TORX, AB, PSVD, WAX	73	EA	
31	PE070069	STRAIGHT-THRU BUSHING	1	EA	
32	050267-000	BRACKET, SUPPORT, BOTTOM, OVEN, 30"/36"	1	EA	
33	058554-000	90 DEG ORIFICE FITTING, #34	1	EA	
NI	PB040071	NATURAL BAKE ORIFICE #35	1	EA	
Not Shown	NOTE	(BAKE NAT ORIFICE)		EA	
33	048028-000	90 DEG ORIFICE FITTING #51 DRILL	1	EA	
NI	PB040035	ORIFICE HOOD-#51 9701B1651	1	EA	
Not Shown	NOTE	(BAKE LP ORIFICE)		EA	
34	PD040004	GROMMET BUMPER	2	EA	
35	PD020067	' #6 X 3/8" PAN PHIL. TEK *SS*	4	EA	
36	pd020232	#8 X 3/4" PH PAN HEAD TEK SCREW (BLACK OXIDE)	4	EA	
37	G9105526BK	OVEN BOTTOM ASSY, BK	1	EA	
Not Shown	NOTE	(MUST ORDER ITEM 1)		EA	
38	A2005525	OVEN BOTTOM HEAT SHIELD	1	EA	
39	008026-000	#6-20 HEX WASHER SS SCREW	12	EA	

Decor View

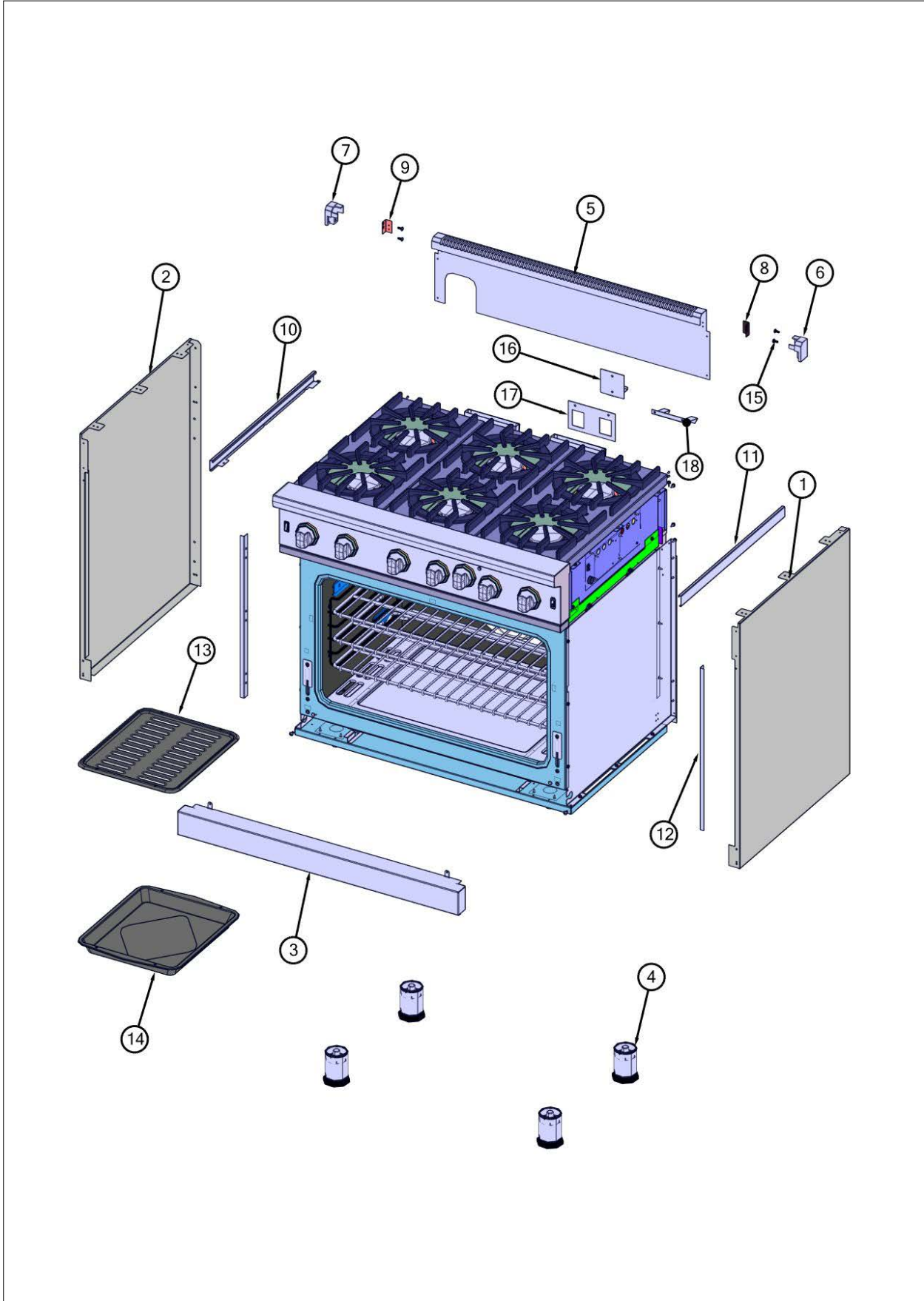



Item	Part No.	Name	Qty	Uom	NOTES
1	019124-000	PANEL, SIDE, RIGHT	1	EA	
1	021309-002	PANEL, SIDE, RIGHT BK	1	EA	
1	021309-005	PANEL, SIDE, RIGHT GG	1	EA	
1	021309-006	PANEL, SIDE, RIGHT WH	1	EA	
1	021309-008	PANEL, SIDE, RIGHT BU	1	EA	
1	021309-013	PANEL, SIDE, RIGHT CB	1	EA	
1	021309-024	PANEL, SIDE, RIGHT AR		EA	
2	019123-000	PANEL, SIDE, LEFT	1	EA	
2	021310-002	PANEL, SIDE, LEFT BK	1	EA	
2	021310-005	PANEL, SIDE, LEFT GG	1	EA	
2	021310-006	PANEL, SIDE, LEFT WH	1	EA	
2	021310-008	PANEL, SIDE, LEFT BU	1	EA	
2	021310-013	PANEL, SIDE, LEFT CB	1	EA	
2	021310-024	PANEL, SIDE, LEFT AR	1	EA	
3	042287-000	KICKPLATE, GAS & DUAL FUEL, 36"	1	EA	
3	042323-002	KICKPLATE, GAS & DUAL FUEL, 36" BK	1	EA	
3	042323-005	KICKPLATE, GAS & DUAL FUEL, 36" GG	1	EA	
3	042323-006	KICKPLATE, GAS & DUAL FUEL, 36" WH	1	EA	
3	042323-008	KICKPLATE, GAS & DUAL FUEL, 36" BU	1	EA	
3	042323-013	KICKPLATE, GAS & DUAL FUEL, 36" CB	1	EA	
3	042323-024	KICKPLATE, GAS & DUAL FUEL, 36" AR	1	EA	
4	044178-000	RANGE, LEG, ADJUSTABLE	1	EA	
5	041504-000	TRIM, IS, 36"	1	EA	
6	037223-000	ENDCAP, IS, BR, CPLT, RH	1	EA	Not available online / Call for pricing and availability
7	037295-000	ENDCAP, IS, BR, CPLT, LH	1	EA	Not available online / Call for pricing and availability

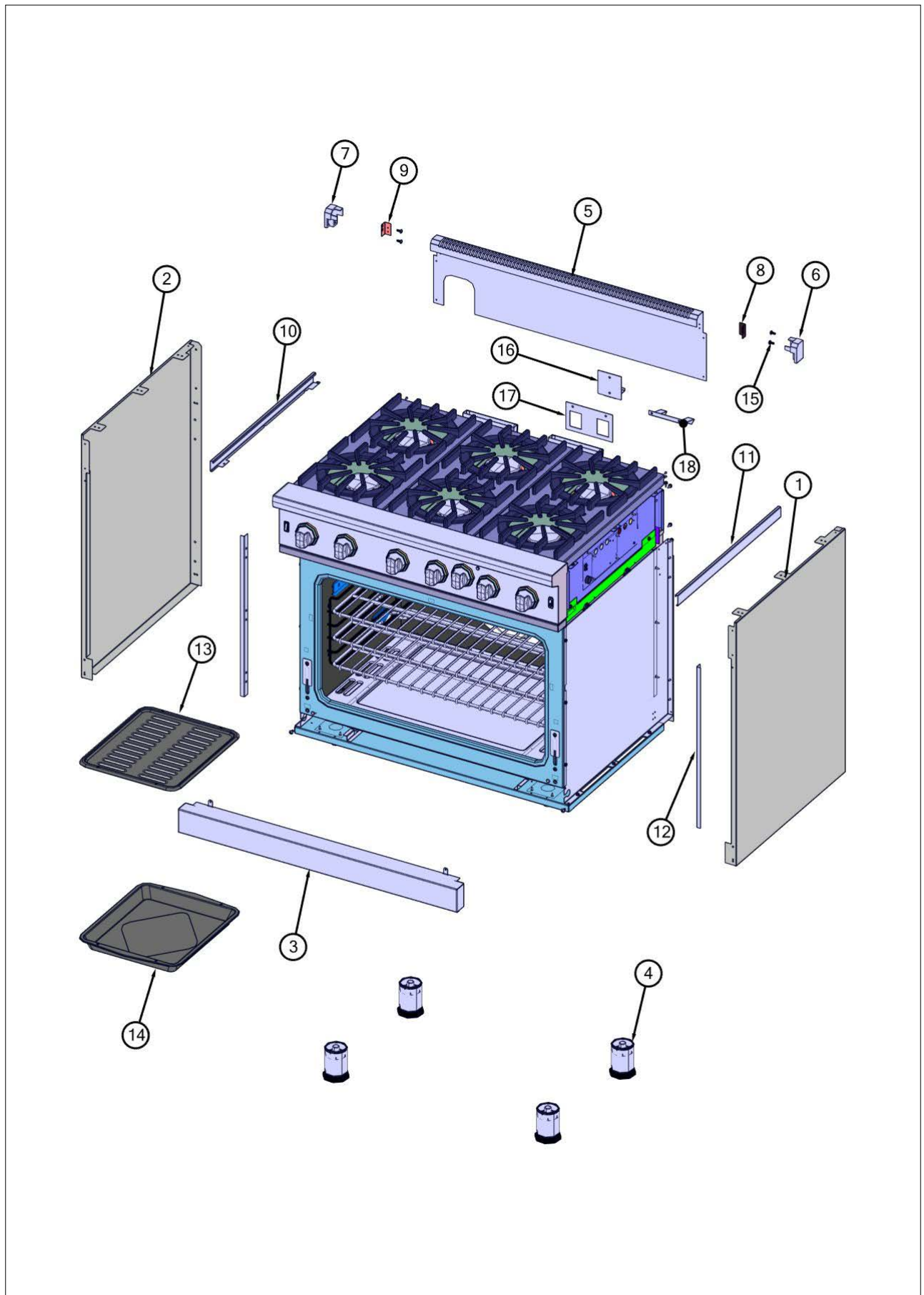



Item	Part No.	Name	Qty	Uom	NOTES
8	040861-000	BRACKET, ENDCAP, RIGHT	1	EA	Not available online / Call for pricing and availability
9	040862-000	BRACKET, ENDCAP, LEFT	1	EA	Not available online / Call for pricing and availability
10	015497-000	TRIM, SIDE LH	1	EA	
11	015496-000	TRIM, SIDE RH	1	EA	
12	005536-000	TRIM	2	EA	
13	042251-000	PAN, GRILL, TOP, PORCELAIN	1	EA	
14	042252-000	PAN, BROILER, BTM, PORCELAIN	1	EA	
15	PD020056	' #10-24 X 1/2" PH.TR. M.S. *SS*	4	EA	
16	A2002654	ANTI-TIP DEVICE (VDSC)	1	EA	
17	034927-000	BRACKET, ANTI-TIP	1	EA	
18	034928-000	BRACKET, HOOK, ANTI-TIP	1	EA	

Top Interior Cooking View

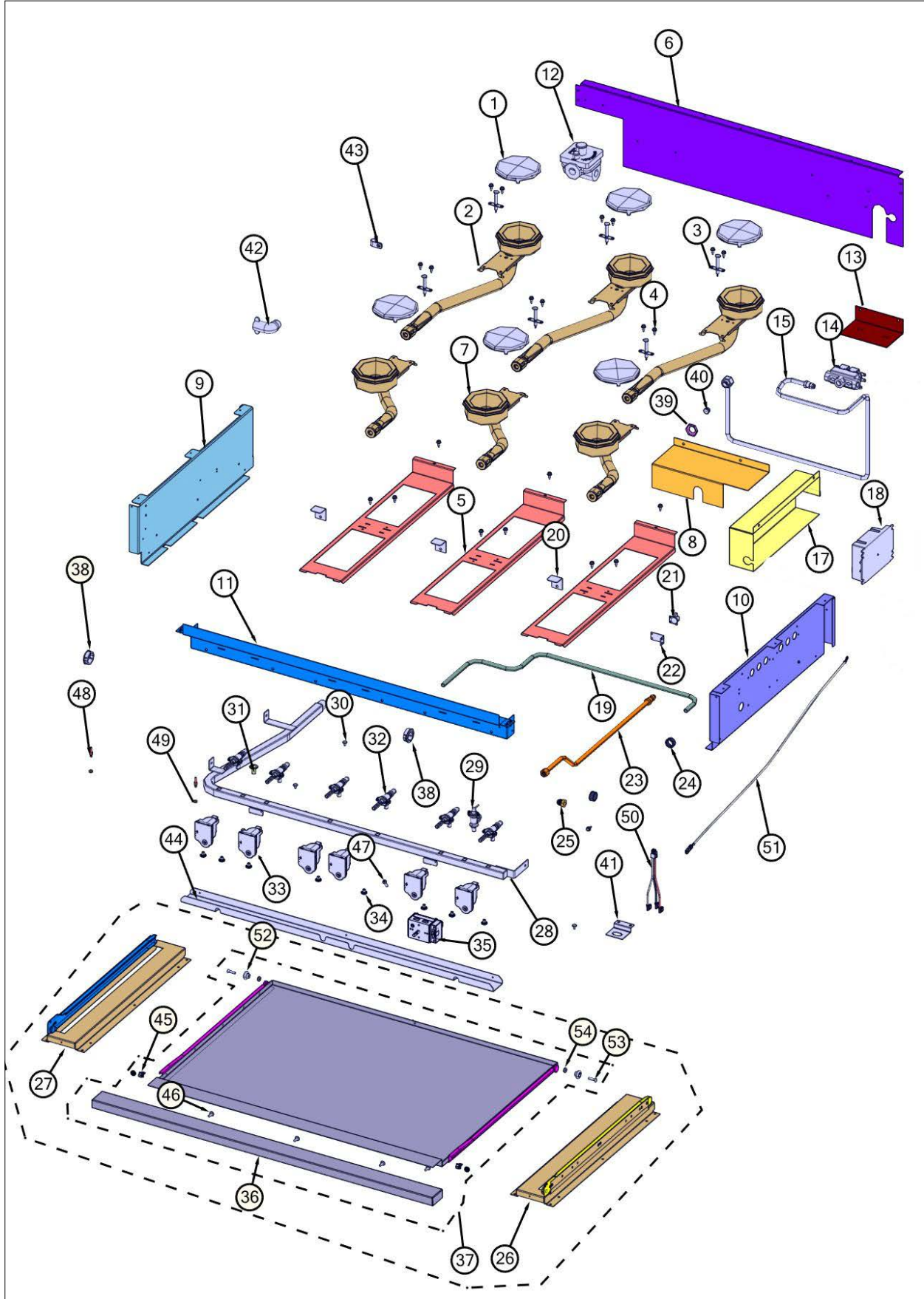



Item	Part No.	Name	Qty	Uom	NOTES
1	066982-000	CAP, BURNER, OPEN, BLK	6	EA	
2	015493-000	BURNER, REAR, ASM	3	EA	
3	PA020028	SPARK IGNITER	6	EA	
4	003860-000	10-18 x .500 FASTNR,SCR,HXWH,STL,ZPLT	34	EA	
5	015485-000	SUPPORT, BURNER, VGIC	3	EA	
6	015762-000	SUPPORT, REAR VGIC536	1	EA	Not available online / Call for pricing and availability
7	015486-000	BURNER, FRONT, ASM	3	EA	
8	016980-000	COVER, VALVE, 30"	1	EA	
9	049578-000	PNL, SIDE, RANGE, LEFT TOP	1	EA	
10	016658-000	BURNER BOX SIDE, RH	1	EA	
11	017140-000	SUPPORT, FRONT 36" ASM	1	EA	
12	PA070003	PRESSURE REGULATOR (NAT.)	1	EA	
12	013386-000	LP PRESSURE REGULATOR	1	EA	
13	015515-000	BRACKET, VALVE	1	EA	
14	009112-000	VALVE, SOL, DOUBLE	1	EA	
15	016952-000	TUBING, BROIL 36" ASM	1	EA	
17	016780-000	COVER, DSI	1	EA	
18	023651-000	DSI120-2-LVS	1	EA	
19	PB020112	3/8 SS FLEX TUBING - 36" T6- 36	1	EA	
20	059122-000	BRACKET, ANGL, AL	3	EA	
21	PJ030039	BI-METAL THERMOSTAT 275 DEGREES	1	EA	
22	A20014089	DISC BRACKET	1	EA	
23	015529-000	TUBING, VALVE, RH OVEN	1	EA	
24	PD040005	SNAP BUSHING - 7/8	3	EA	
25	PB040050	3/8CC MALE COMP. FITTING W/FERRULE	1	EA	
26	015501-000	BRACKET, SLIDE ASM RH	1	EA	Not available online / Call for pricing and availability

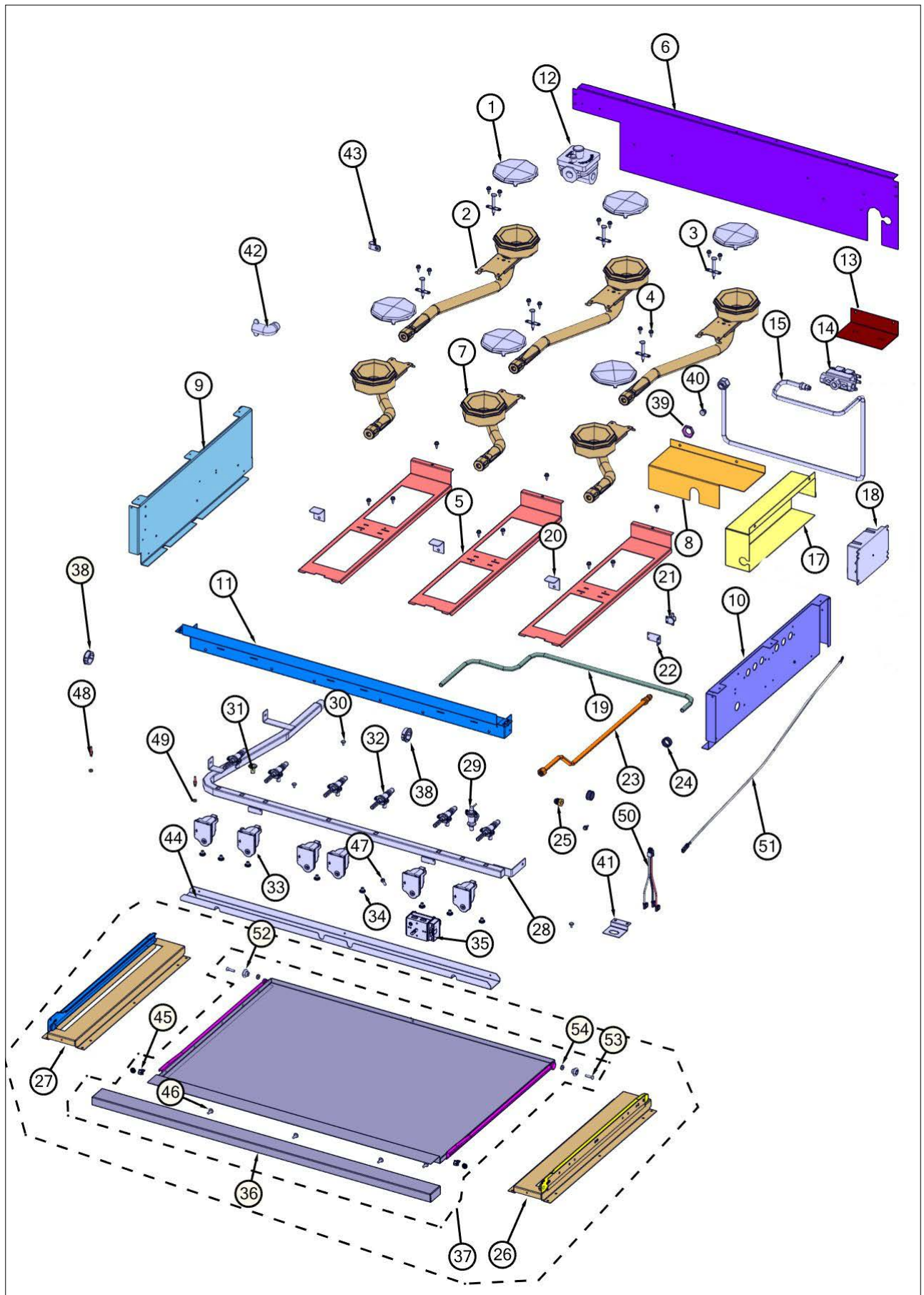

Item	Part No.	Name	Qty	Uom	NOTES
Not Shown	NOTE	(IF REPLACED, MUST REPLACE #26, #27, #37 WITH 061181-000, 061191-000, AND 061179-000)		EA	
27	015505-000	BRACKET, SLIDE ASM LH	1	EA	
Not Shown	NOTE	(IF REPLACED, MUST REPLACE #26, #27, #37 WITH 061181-000, 061191-000, AND 061179-000)		EA	
28	015784-000	MANIFOLD, 36"	1	EA	
29	007147-000	SHUT OFF VALVE	1	EA	
30	PD020032	SRW-8(A)X3/8"PH.WFR HD 7/16DIA*NICL	6	EA	
31	002884-000	MANIFOLD PLUG	1	EA	
32	023405-000	VALVE, BURNER, TOP, NAT.	6	EA	
32	023501-000	VALVE, BURNER, TOP, LP	6	EA	
33	PA020058	IRIS SINGLE SPARK MODULE	6	EA	
34	PD010012	VALVE BOLT 1/4-20 UNC-2B 5/16" M.S.	8	EA	
35	013213-000	TSTAT, SMPS, ELEC, 2-POS, .91" SHAFT, CB	1	EA	
36	044051-000	TRAY, DRIP, HANDLE 36"	1	EA	
37	043664-000	TRAY, DRIP, ASSEMBLY 36"	1	EA	
Not Shown	NOTE	(IF REPLACED, MUST REPLACE #26, #27, #37 WITH 061181-000, 061191-000, AND 061179-000)		EA	
38	PD040152	SNAP BUSHING	2	EA	
39	PD030018	PALNUT - 3/4-16	2	EA	
40	pb040040	ORIFICE-IR BURNER (VGSC)	1	EA	
40	PB040027	IR BUR.SPUD ORF. - #56 LP	1	EA	
41	005280-000	DISCONNECT BRKT	1	EA	
42	PB040070	CONDUIT FITTING (90 DEG)	1	EA	
43	PD030118	INSULATED CLAMP	1	EA	
44	058604-000	SHIELD, DRIP, VGIC536	1	EA	
45	PD950012	STRIKE PANEL ACCESS	2	EA	
46	PD010003	10-24 X 1/2 PH.TR.HD.SERD.M.S.	4	EA	
47	PD020079	#10 X 1 1/4 PH. PAN HD. T(A) NYLOK	1	EA	

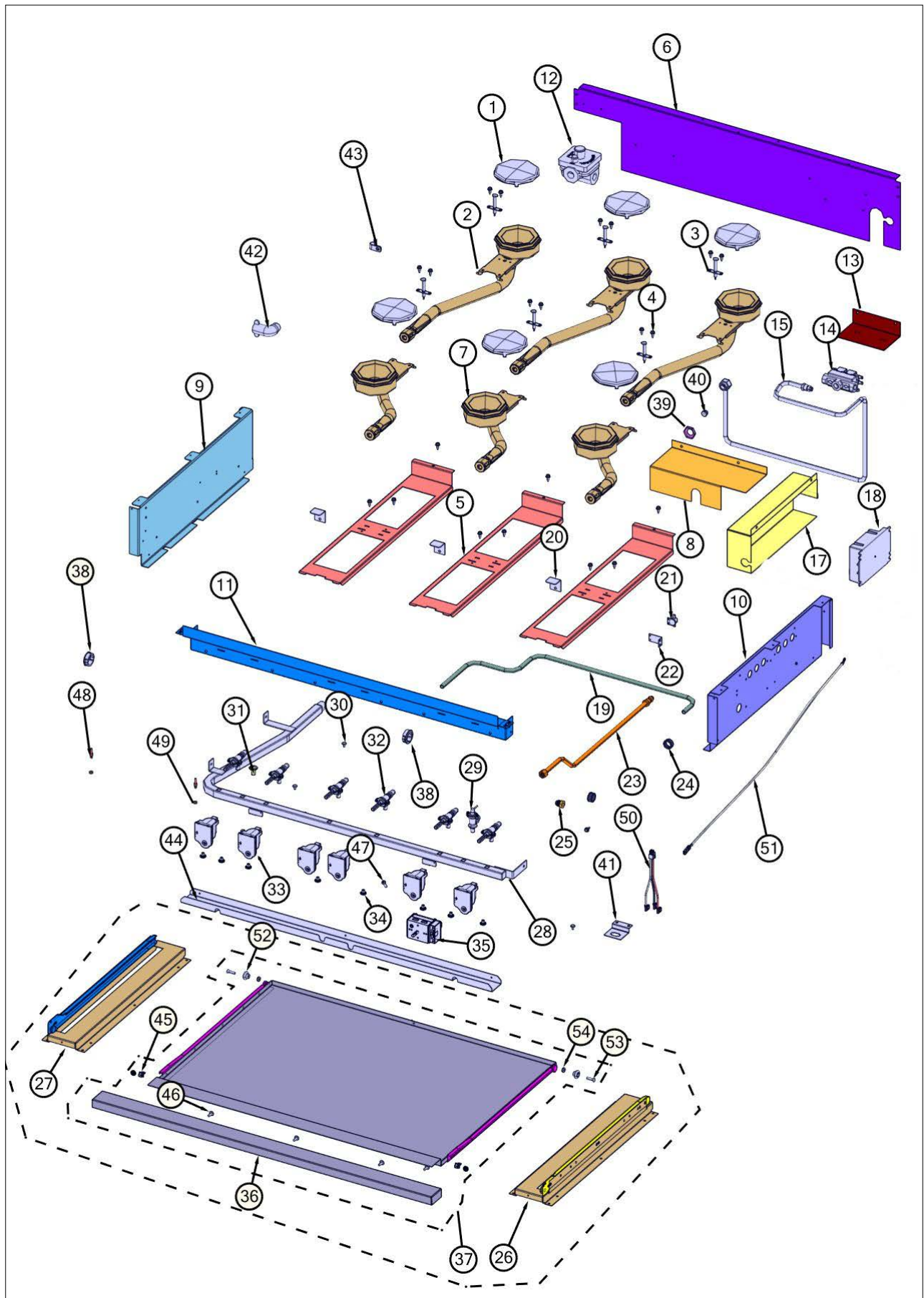



Item	Part No.	Name	Qty	Uom	NOTES
48	PD010017	BALL STUD (VGRT)	2	EA	
49	PD030012	6-32 HEX NUT	2	EA	
50	023040-000	HARNESS, CNVN, SWITCH, ASM	1	EA	
51	058704-000	HARN, VGIC, GROUND	1	EA	
52	PC020025	DRIP TRAY WHEEL	2	EA	
53	PD020082	10 X 24 COUNTERSUNK S.S. SCREW	2	EA	
54	PD030010	#10-24 KEPS NUT ZINC PLATED	2	EA	
NI	006766-000	IRIS IGNITOR WIRE, BACK BURNER	2	EA	
NI	000647-000	IRIS IGNITOR WIRE, FRONT BURNER	2	EA	

Door View

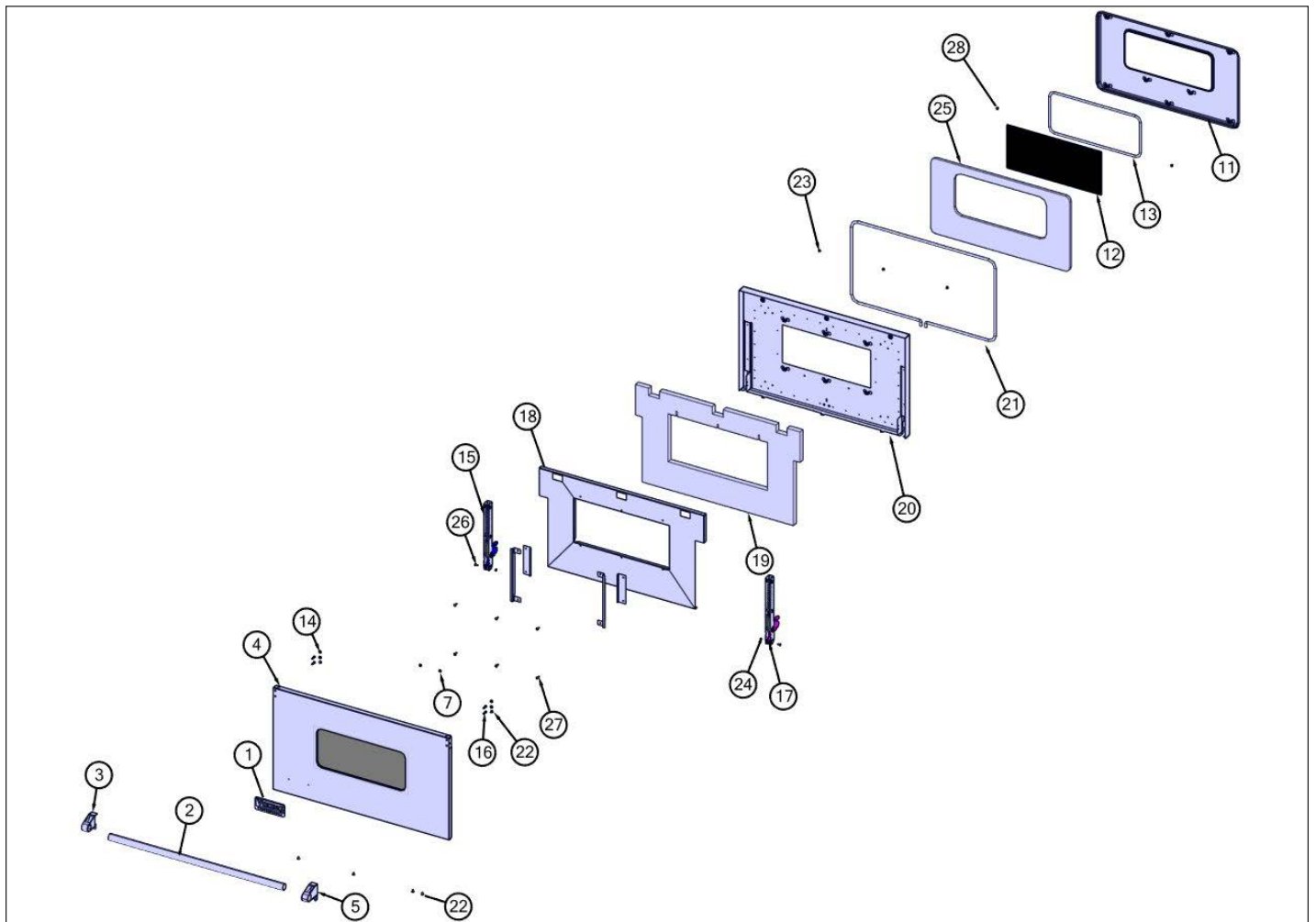



Item	Part No.	Name	Qty	Uom	NOTES
1	PE010030	LOGO 6" (VGRC) *BK*	1	EA	
2	006080-000	36" DOOR HANDLE, 35.5	1	EA	
3	003011-000	DOOR HANDLE ENDCAP ASSY, LH (CHROME)	1	EA	
4	074321-000	PANEL, DOOR, ASM, OTR - SS	1	EA	
4	074329-002	PANEL, DOOR, ASM, OTR - BK	1	EA	
4	074329-005	PANEL, DOOR, ASM, OTR - GG	1	EA	
4	074329-006	PANEL, DOOR, ASM, OTR - WH	1	EA	
4	074329-008	PANEL, DOOR, ASM, OTR - BU	1	EA	
4	074329-013	PANEL, DOOR, ASM, OTR - CB	1	EA	
4	074329-024	PANEL, DOOR, ASM, OTR - AR	1	EA	
5	003012-000	DOOR HANDLE ENDCAP ASSY, RH (CHROME)	1	EA	
7	PD030006	CAPPED WASHER PAL NUT	2	EA	
11	001399-402	DOOR,PLUG,ASM PROC 36 BK	1	EA	
12	PE060039	GLASS-HEAT TREATED (HB2) VDSC	1	EA	
13	000594-000	BLACK FIBERGLASS ROPE 3/8"	4.5ft	EA	
14	004907-000	STEEL FINISHING PLUG, NICKEL PLTD 25/64" HOLE	4	EA	
15	002740-000	DOOR HINGE	1	EA	See TC-0121-SP Service Bulletin
16	030823-000	#10-32 PAN HEAD PHILLIPS MACHINE SCREW	4	EA	
17	013290-000	HINGE, DOOR, VGCC36" - PINK SPRING	1	EA	

Comments for Part Num. 013290-000

CAREYSAPPLIANCE@HOTMAIL.COM on Feb 15, 2018

in door view hinges are showing 2 different hinges

#15) part 002740-000

#17) part 013290-000

these part numbers in middleby do not cross over to each other

please correct with the correct part numbers Thanks Dan

18	007883-000	RETAINER LINER, 36"	1	EA	
19	023572-000	INSULATION, DOOR LINER, 36"	1	EA	

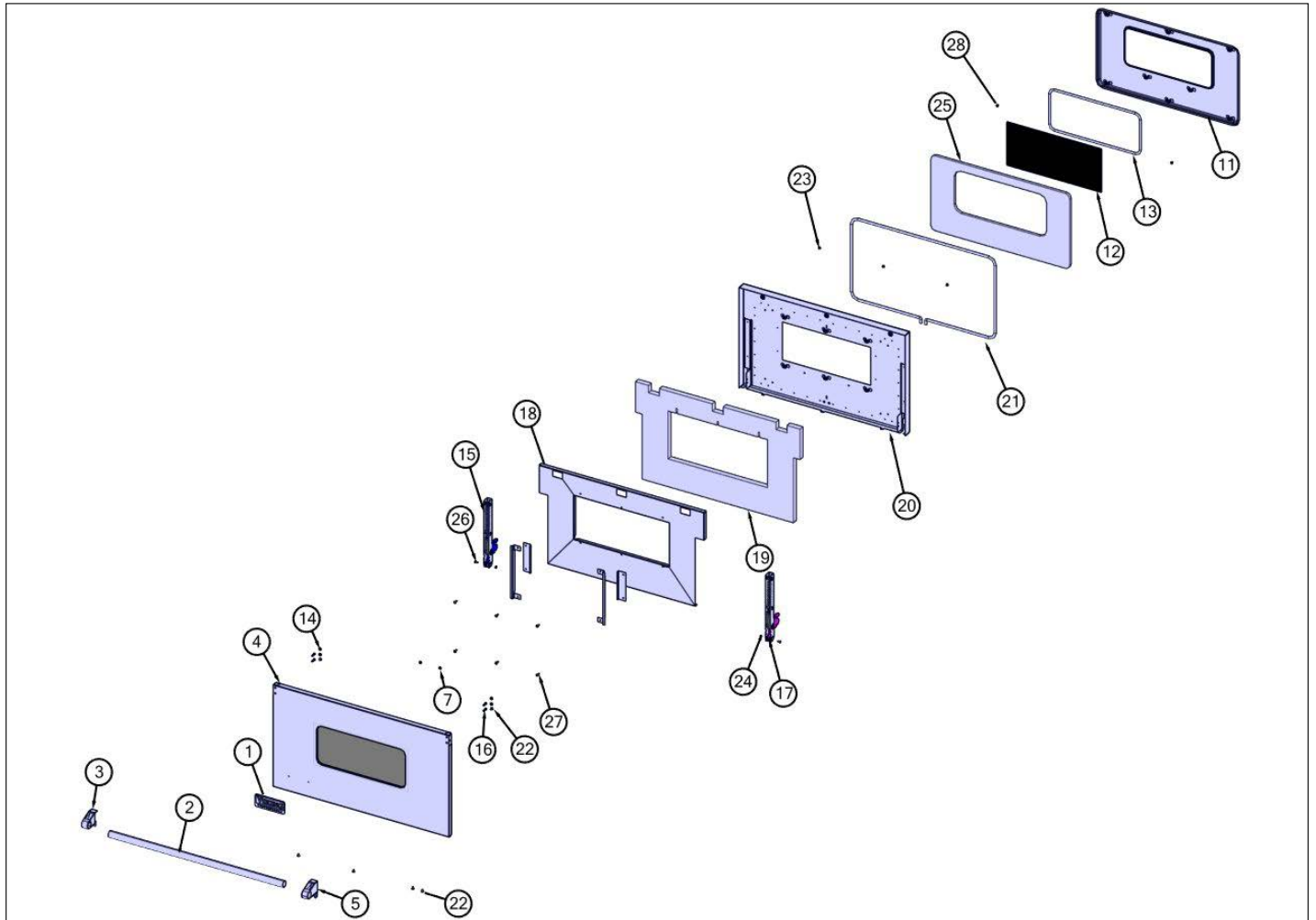



Item	Part No.	Name	Qty	Uom	NOTES
20	008154-402	LINER,DOOR 36" WELD ASM, BK	1	EA	
21	000090-000	36" DOOR GASKET	1	EA	
22	PD020033	SRW-#10-24X1/2"(23)PH.WFR HD (NKL)	3	EA	
23	PD020063	SCREW-#8(A) X 3/8"PH WFR HD/BK OXID	3	EA	
24	PD030010	#10-24 KEPS NUT ZINC PLATED	6	EA	
25	002562-000	36" DOOR PLUG INSULATION	1	EA	
26	PD010003	10-24 X 1/2 PH.TR.HD.SERD.M.S.	2	EA	
27	PD020014	10X3/4 PH TR HD SMS	6	EA	
28	PD020063	SCREW-#8(A) X 3/8"PH WFR HD/BK OXID	2	EA	

Bottom View

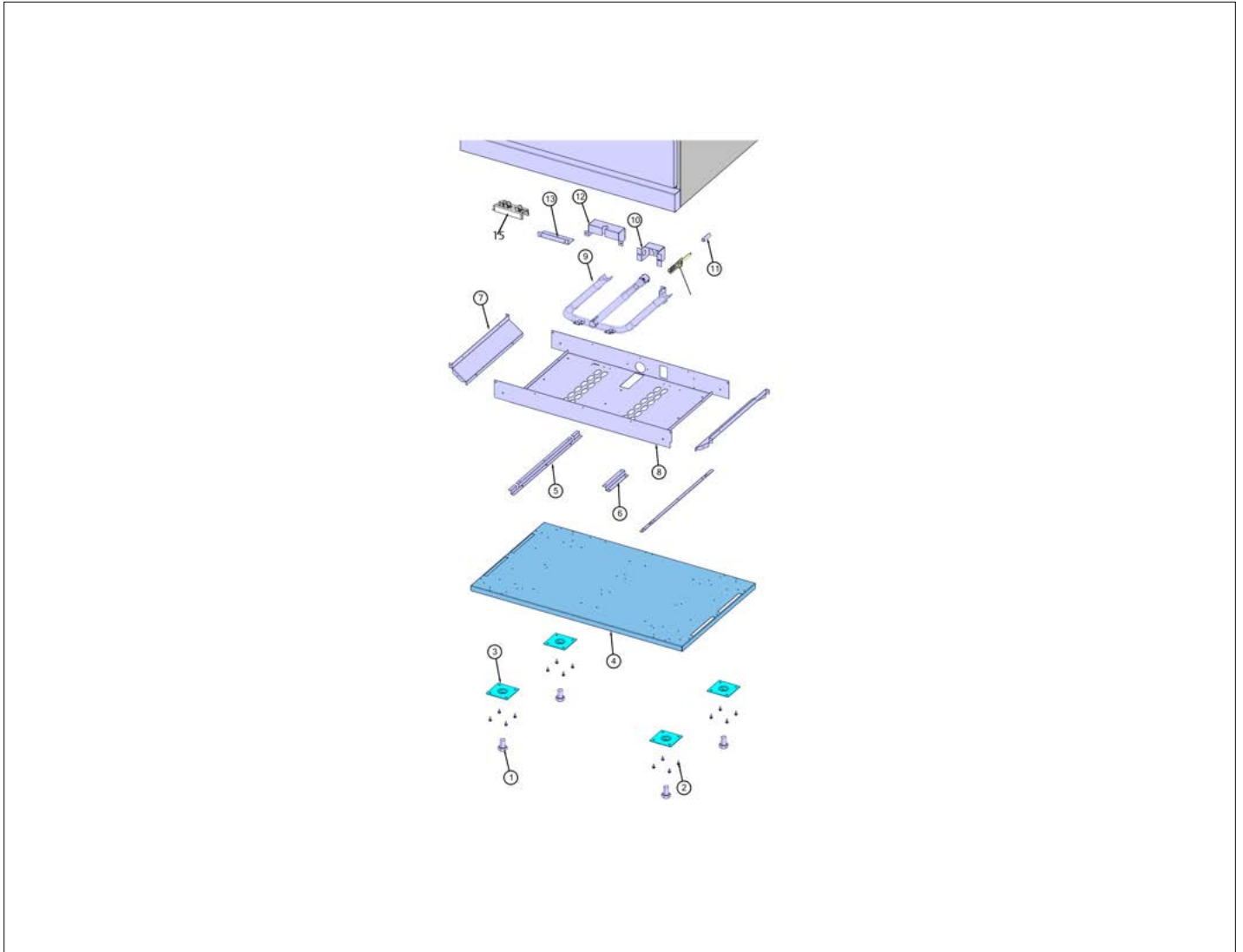



Item	Part No.	Name	Qty	Uom	NOTES
1	PD010022	HEX HD. BOLT - 3/4-10 X 1-1/4"	4	EA	
2	003860-000	10-18 x .500 FASTNR,SCR,HXWH,STL,ZPLT	16	EA	
3	PC030007	LEG PLATE - 3/4" THREADED HOLE	4	EA	
4	020604-000	BASE, RANGE	1	EA	
5	A2004429	OVEN BOTTOM INSUL. BRACE (VGSC306)	2	EA	
6	050794-000	BRACKET, HOLD-DOWN, BOX FIRE	1	EA	
7	014747-000	BRACKET, BNR, SIDE, PORCELAIN	2	EA	
8	043730-000	OVEN CVTY, BTM, 36"	1	EA	
9	043276-000	BURNER, BAKE, ASM, 36"	1	EA	
9	044236-000	BURNER, BAKE, ASM, 36"- LP	1	EA	
10	040736-000	BRKT, ORF	1	EA	
11	039137-000	TUBING, INSUL, GAS IGNITOR	1	EA	
12	031961-000	COVER, TERM. BLOCK	1	EA	
13	007484-000	TERMINAL, BLOCK, BRACKET	1	EA	
14	PB040170	BAKE IGNITION ELECTRODE	1	EA	
15	007400-000	BLOCK, TERMINAL	1	EA	

Wiring View 1

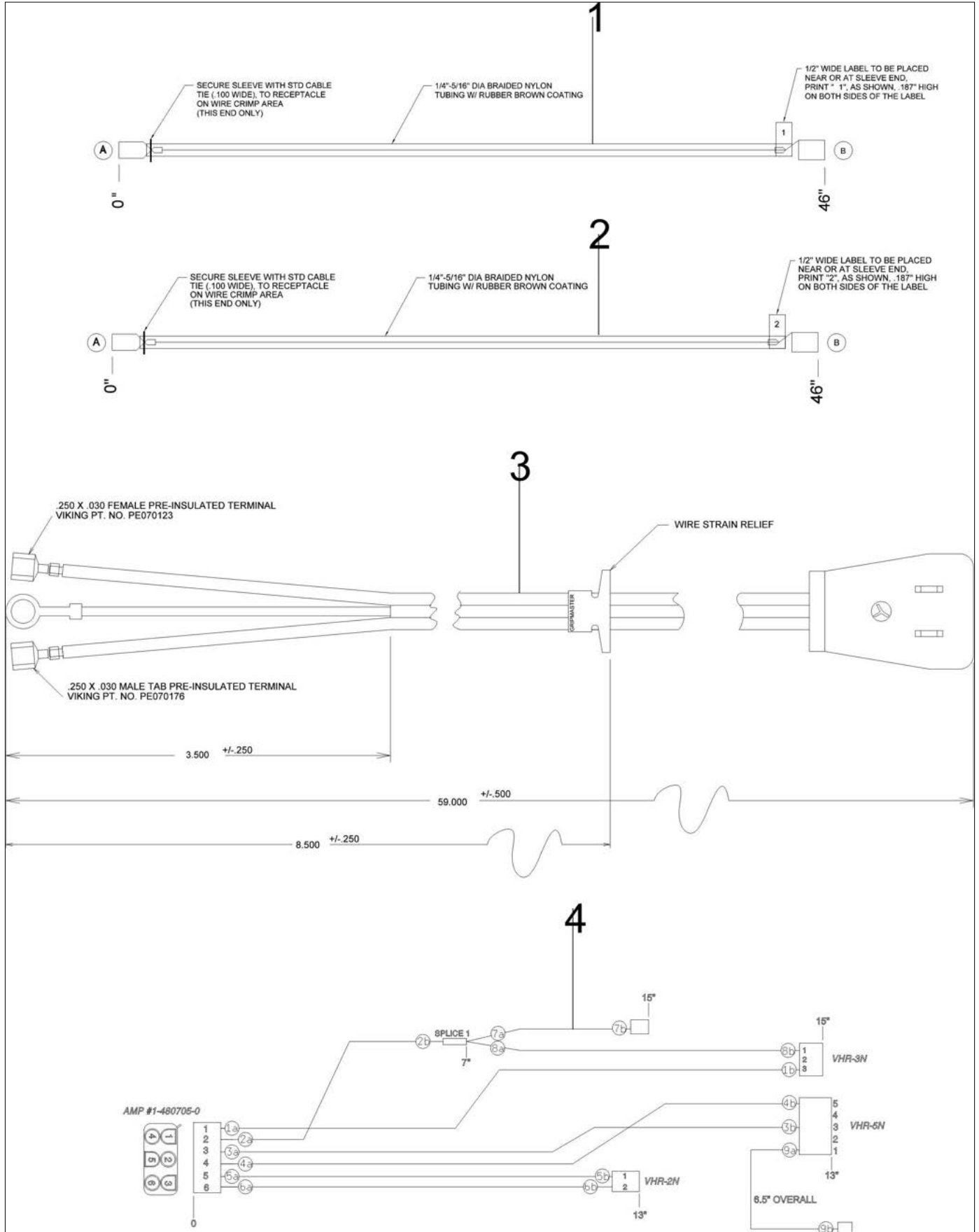



Item	Part No.	Name	Qty	Uom	NOTES
1	024606-000	WIRE, BAKE, ELECTRODE, ASM	1	EA	
2	024605-000	WIRE, BRL, ELECTRODE, ASM	1	EA	
3	023750-000	CORD, SUPPLY	1	EA	
4	036193-000	HARNESS, CONTROL, BK/BR	1	EA	

Wiring View 2

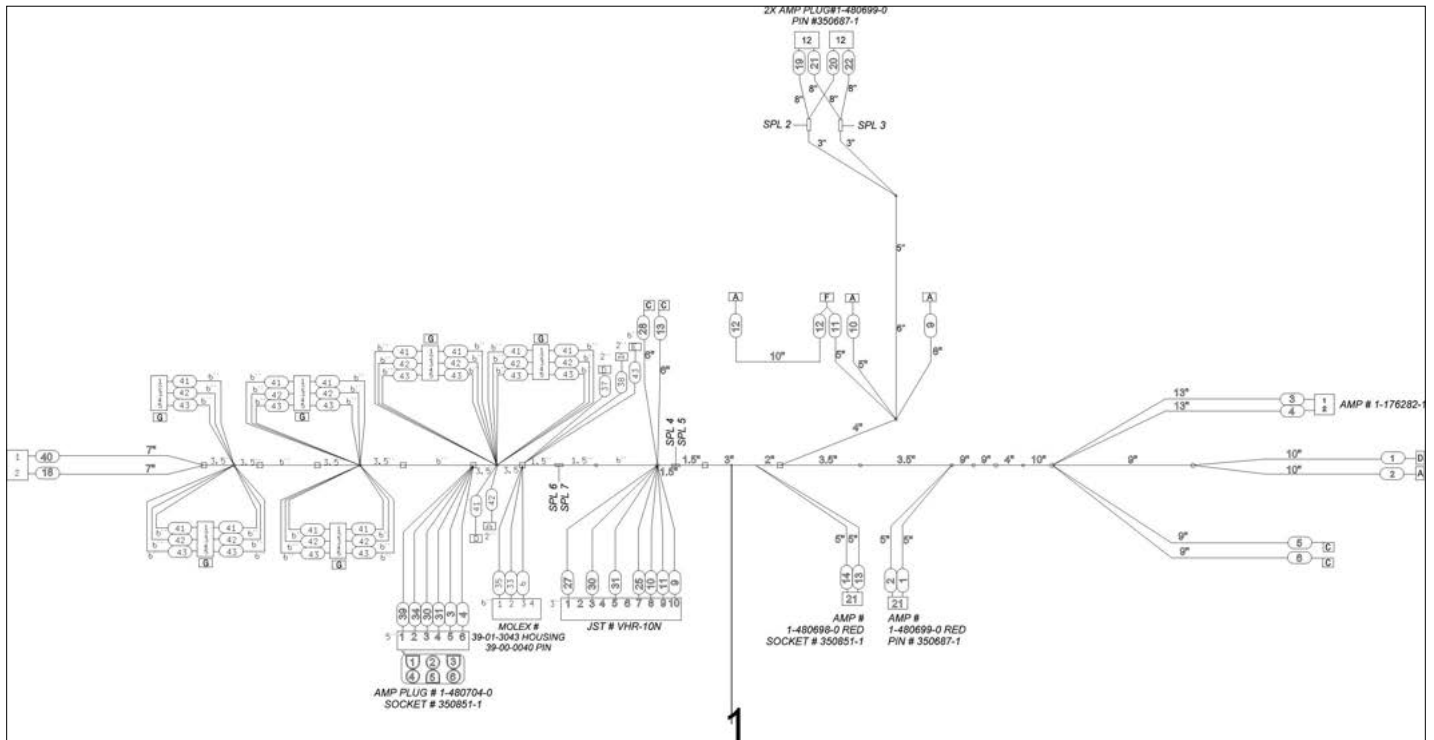



Item	Part No.	Name	Qty	Uom	NOTES
1	040205-000	HARNESS, W, VGIC5366B	1	EA	Not available online / Call for pricing and availability



Appendix A:Pages Index

Bottom View 7
Cavity View 3
Control View 1
Decor View 4
Door View 6
Surface Cooking View 2
Top Interior Cooking View 5
Wiring View 1 8
Wiring View 2 9



Appendix B:Parts Index

000090-000	6	015497-000	4
000594-000	6	015501-000	5
000647-000	5	015505-000	5
001399-402	6	015515-000	5
002562-000	6	015529-000	5
002740-000	6	015753-000	3
002884-000	5	015762-000	5
003011-000	6	015784-000	5
003012-000	6	016658-000	5
003083-000	1	016780-000	5
003719-000	1	016952-000	5
003860-000	1, 5, 7	016980-000	5
004479-000	3	017140-000	5
004482-000	3	017763-000	3
004907-000	6	019123-000	4
005280-000	5	019124-000	4
005536-000	4	019327-402	3
005944-000	3	020409-000	3
005945-000	3	020412-000	3
006080-000	6	020604-000	7
006766-000	5	021225-402	3
007008-000	3	021309-002	4
007147-000	5	021309-005	4
007400-000	7	021309-006	4
007484-000	7	021309-008	4
007841-000	3	021309-013	4
007849-402	3	021309-024	4
007883-000	6	021310-002	4
008026-000	3	021310-005	4
008154-402	6	021310-006	4
009112-000	5	021310-008	4
013213-000	5	021310-013	4
013290-000	6	021310-024	4
013386-000	5	023040-000	5
014747-000	7	023090-000	3
015170-000	1	023405-000	5
015485-000	5	023501-000	5
015486-000	5	023572-000	6
015493-000	5	023651-000	5
015496-000	4	023750-000	8
		024010-000	1



024011-000	1	045034-000	3
024605-000	8	048028-000	3
024606-000	8	049578-000	5
025098-000	1	049718-402	3
027968-000	1	050172-000	1
030823-000	6	050267-000	3
031445-000	3	050794-000	7
031679-000	3	058554-000	3
031961-000	7	058604-000	5
032208-000	3	058680-2256	1
032858-402	3	058704-000	5
034927-000	4	059122-000	5
034928-000	4	066210-000	3
035881-000	1	066225-402	3
035891-000	1	066982-000	5
036193-000	8	068653-601	3
037223-000	4	074321-000	6
037295-000	4	074329-002	6
037304-000	3	074329-005	6
039137-000	7	074329-006	6
040205-000	9	074329-008	6
040736-000	7	074329-013	6
040861-000	4	074329-024	6
040862-000	4	A20012649	3
040865-000	3	A20014089	5
041504-000	4	A2002654	4
042251-000	4	A2004429	7
042252-000	4	A2005525	3
042287-000	4	E9101115BK	2
042323-002	4	G9105526BK	3
042323-005	4	PA020028	5
042323-006	4	PA020058	5
042323-008	4	PA030002BK	2
042323-013	4	PA060037	2
042323-024	4	PA070003	5
043276-000	7	PB020112	5
043664-000	5	PB040027	3, 5
043730-000	7	PB040035	3
044051-000	5	PB040040	3
044178-000	4	PB040050	5
044236-000	7	PB040070	5



PB040071	3
PB040170	7
PB040171	3
PC020025	5
PC030007	7
PD010003	5, 6
PD010012	5
PD010017	5
PD010022	7
PD020014	6
PD020032	5
PD020033	6
PD020046	3
PD020056	4
PD020063	6, 6
PD020067	3
PD020079	5
PD020082	5
PD030006	6
PD030010	5, 6
PD030012	5
PD030018	5
PD030118	5
PD040004	3
PD040005	5
PD040152	5
PD950012	5
PE010030	6
PE050208	3
PE060039	6
PE070069	3
PJ030039	5
g3001876	3
pb040040	5
pd020073	1
pd020232	3