

Ref #	Part Number	Qty.	Description
1	PD010003		10-24 X 1/2 PH.TR.HD.SERD.M.S.
2	G3006766		SEALED LANDING LEDGE ASSY
3	PA070001		PRESSURE REGULATOR (NAT.)
4	PD030005		SELF RETAINING NUT
5	A1001138		MANIFOLD BRKT
6	PA010158		SUB TO 003517-000 - SEALED BURNER FLARE VALVE
7	PA010012		ROPER PLUG
8	PA020058		IRIS SINGLE SPARK MODULE
9	PA050113		MANIFOLD
10	B9201332		CTRL PAN-VGRT300-4BSS XSLK SCRX
	C9201332AL		CTRL PAN- XALX (VGRT300-4B)XSLK S
	C9201332BK		CTRL PAN- XBKX (VGRT300-4B)XSLK S
	C9201332BT		CONTROL PANEL VGRT300-4B XBTX SILK SCR
	C9201332BU		CONTROL PANEL VGRT300-4B XBUX SILK SCR
	C9201332CB		CONTROL PANEL VGRT300-4B XCBX SILK SCR
	C9201332EP		CONTROL PANEL VGRT300-4B XEPX SILK SCR
	C9201332FG		CONTROL PANEL VGRT300-4B XFGX SILK SCR
	C9201332GG		CONTROL PANEL VGRT300-4B XGGX SILK SCR
	C9201332LE		CONTROL PANEL VGRT300-4B XLEX SILK SCR
	C9201332MJ		CONTROL PANEL VGRT300-4B XMJX SILK SCR
	C9201332SG		CONTROL PANEL VGRT300-4B XSGX SILK SCR
	C9201332VB		CONTROL PANEL VGRT300-4B XVBX SILK SCR
	C9201332WH		CTRL PAN- XWHX (VGRT300-4B)XSLK S
11	PD020002		10 X 1/2 PH.TR.HD.SMS.
12	A20011466		FALSE DRIP TRAY HANDLE BRKT. LH
13	PD030006		CAPPED WASHER PAL NUT
14	PD010012		VALVE BOLT 1/4-20 UNC-2B 5/16 M.S.
15	A20011467		FALSE DRIP TRAY HANDLE BRKT. RH
16	PD020032		SRW-8(A)X3/8PH.WFR HD 7/16DIAXNICL
17	B30011468		FALSE DRIP TRAY HANLDE (WELDED) - 30
	G93011458PVD		DRIP TRAY HANDLE ASSY 30 PVD
18	PD020033		SRW-NO.10-24X1/2T(23)PH.WFR HD (NKL)
19	PB010208		BEZEL, CHROME PLATE
	PB010209		BEZEL BRASS
20	PD020067		NO.6 X 3/8 PAN PHIL. TEK SS
21	PB010206		VGSC,VGRC,VGRT TOP BURNER KNOB(BK)
	PB010207		VGSC,VGRC,VGRT TOP BURNER KNOB(WH)
22	PE010142		3 LOGO XBKXXCHROME
	PE010143		3 LOGO BK/BR
	PE010144		3 LOGO XWHXCHROME
	PE010145		LOGO - WH / BR

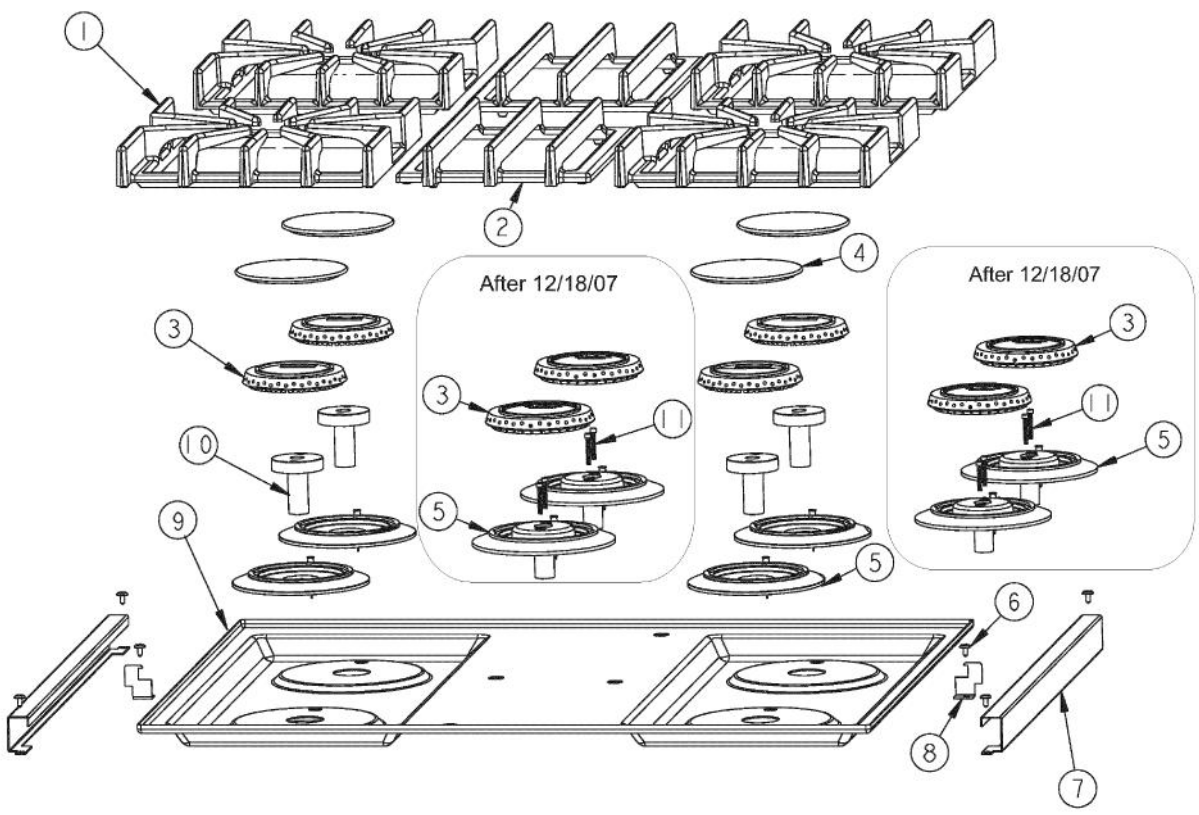

Ref #	Part Number	Qty.	Description
1	PA060054		SEALED GRATE XBKX
2	PA060060		SEALED COOKTOP CENTER GRATE XBKX
3	PB050063		BURNER HEAD (BEFORE 12/18/07)
	001386-000		BURNER HEAD (AFTER 12/18/07)
4	PA080083		D BURNER CAP XMATTE BLACKX
5	PB050081		BURNER BASE ASSEMBLY (INCLUDES IGNITER) - BEFORE 12/18/07
	003322-040		SEALED BURNER BASE, TURNED FINISH (INCLUDES IGNITER) - AFTER 12/18/07
6	PD020032		SRW-8(A)X3/8PH.WFR HD 7/16DIAXNICL
7	B2007851		SIDE TRIM
	C9307851BR		SIDE TRIM XBRX
8	A2007858		SIDE TRIM BRKT
9	E9107413BK		MAIN TOP 30 XBKX
	E9107413WH		MAIN TOP 30 XWHX
10	PA010100		VENTURI D (VDSC3074B) (BEFORE 12/18/07)
11	003606-000		NO.6-32 SOCKET HEAD SCREW (AFTER 12/18/07)

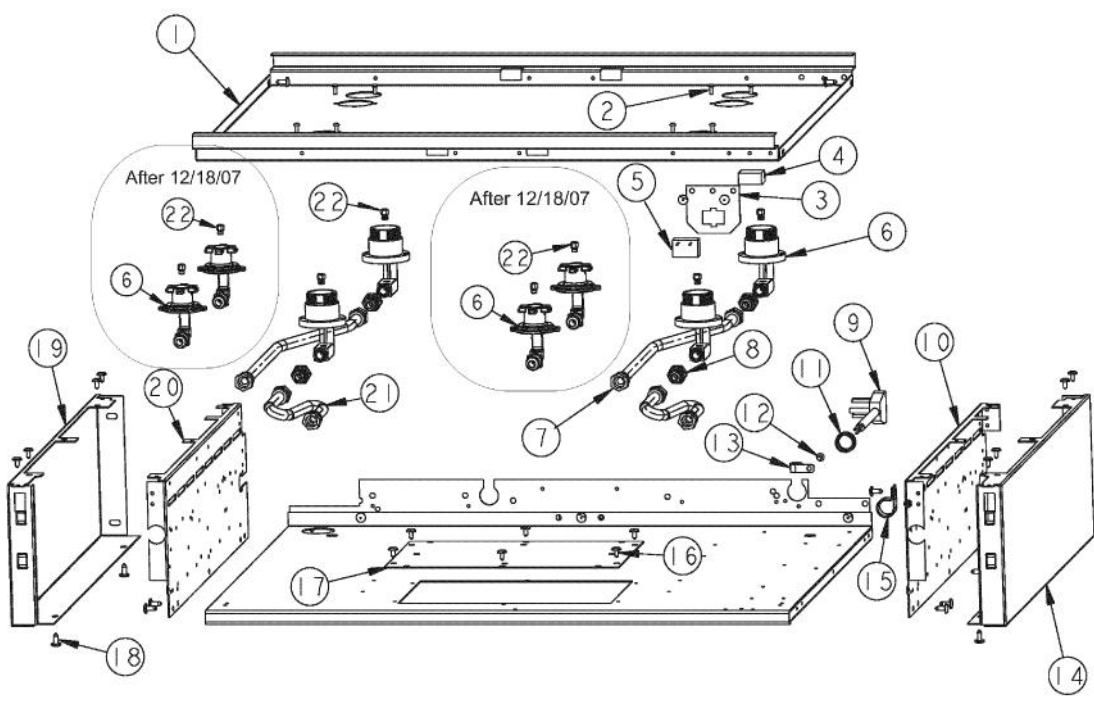

Ref #	Part Number	Qty.	Description
1	A2007852		BURNER SUPPORTS
2	PD020076		6-32 X 3/8 PHILL PAN MS
3	A1008487		SERVICE DISCONNECT BRACKET
4	PE070071		DISCONNECT BLOCK XALX 770027-1
5	000573-000		POWER JUMPER WIRE
6	PA080075		BODY BURNER D (VDSC3074BSS) (BEFORE 12/18/07)
	001394-042		15000 BTU NAT JETHOLDER (AFTER 12/18/07)
	001394-043		13500 BTU LP JETHOLDER (AFTER 12/18/07)
7	PB020193		16 FLEX TUBING W/CONNECTORS
8	PA050086		5/8 MALE FLARE FITTING
9	PE070128		SUPPLY CORD (VGRT/SC/SS/RC)
10	A2006747		BURNER BOX SIDE RH (VDSC3074B)
11	PD040005		SNAP BUSHING - 7/8
12	PD020010		10 X 3/8 GREEN GROUNDING SCREW
13	PD030148		CLAMP CABLE ALUMINUM .500 DIA. (AL-8 CLAMP)
14	B2007856		RT SIDE PANEL
15	PD030109		INSULATED CLAMP
16	PD020032		SRW-8(A)X3/8PH.WFR HD 7/16DIAXNICL
17	A1006344		DOOR LOCK ACCESS PANEL 48
18	PD020002		10 X 1/2 PH.TR.HD.SMS.
19	B2007857		LFT SIDE PANEL
20	A2006748		BURNER BOX SIDE LH (VDSC3074B)
21	PB020192		10 FLEX TUBING W/CONNECTORS
22	PB040194		SEALED RANGE ORIFICE (NAT) (BEFORE 12/18/07)
	001396-040		15K NG ORIFICE (AFTER 12/18/07)
	PB040217		L.P. ORIFICE (BEFORE 12/18/07)
	001396-044		13.5K LP ORIFICE (AFTER 12/18/07)

1

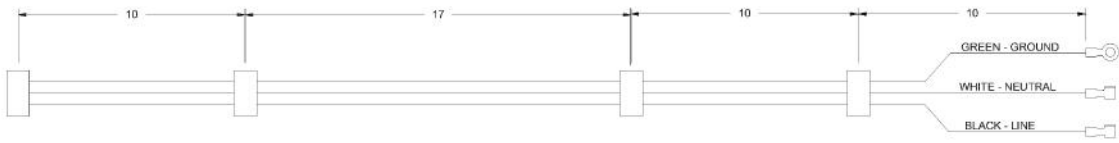

Ref #	Part Number	Qty.	Description
1	PE070889		IRIS HARNESS - 30

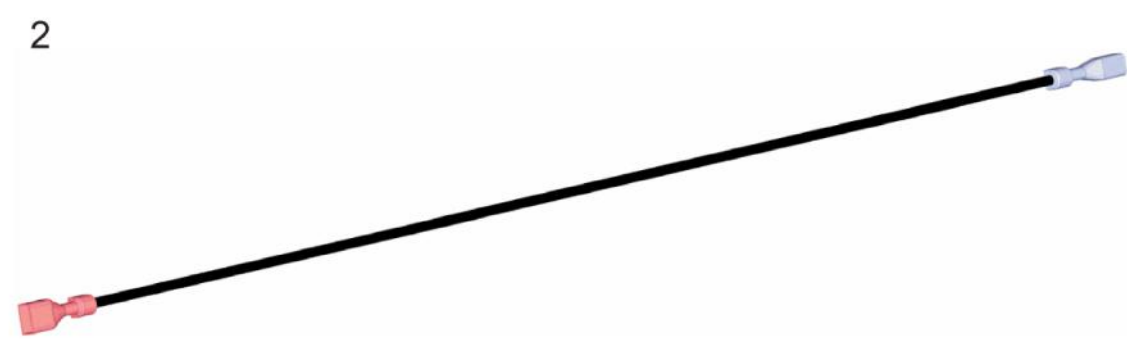
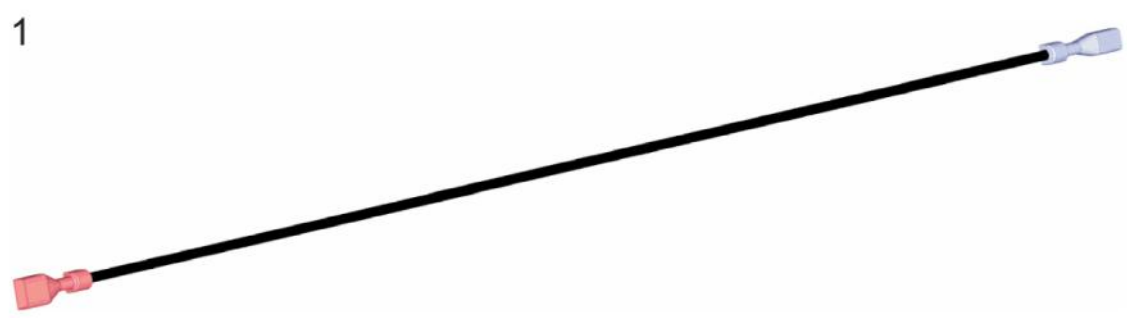

Ref #	Part Number	Qty.	Description
1	000647-000		IRIS IGNITOR WIRE, FRONT BURNER
2	000648-000		IRIS IGNITOR WIRE, BACK BURNER

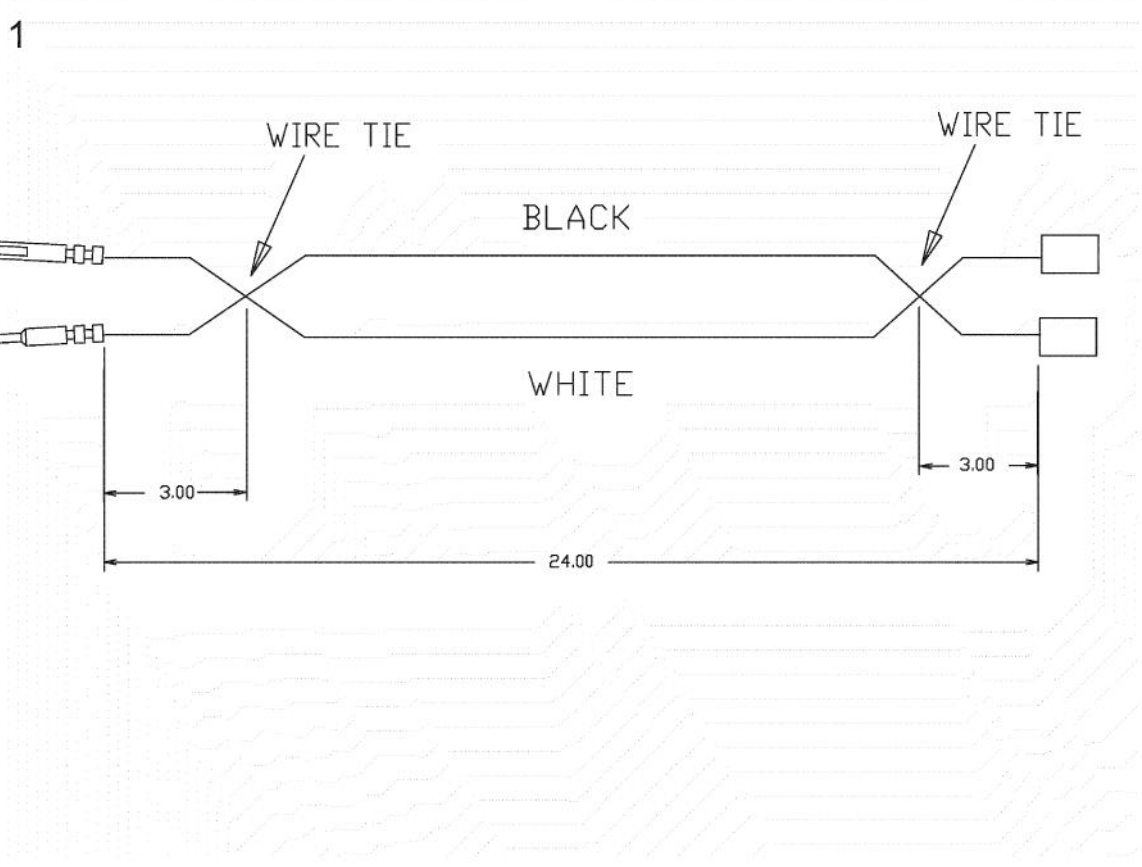

Ref #	Part Number	Qty.	Description
1	000837-000		VGRT SUPPLY CORD JUMPER (BEFORE 10/4/11)
1	027347-000		SUPPLY CORD JUMPER (ON OR AFTER 10/4/11)

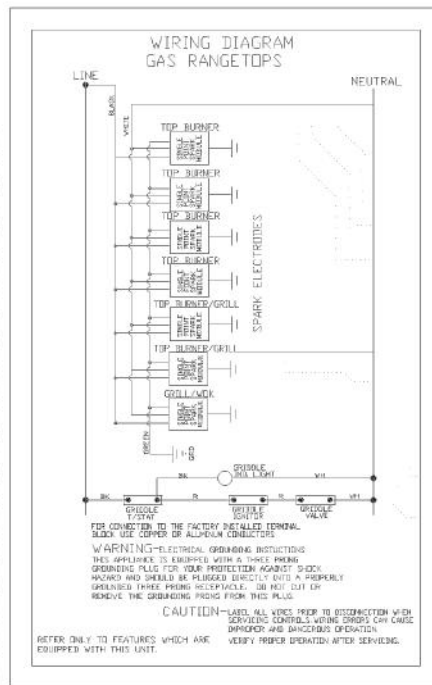

Ref #	Part Number	Qty.	Description
-------	-------------	------	-------------
