

VRT5364GSS

Control View	1
Surface Cooking View	2
Gas Asm View	3
Electrical View	4
Burner Box Asm View	5
Decor View	6
Appendix A:Pages Index	A
Appendix B:Parts Index	B

Control View

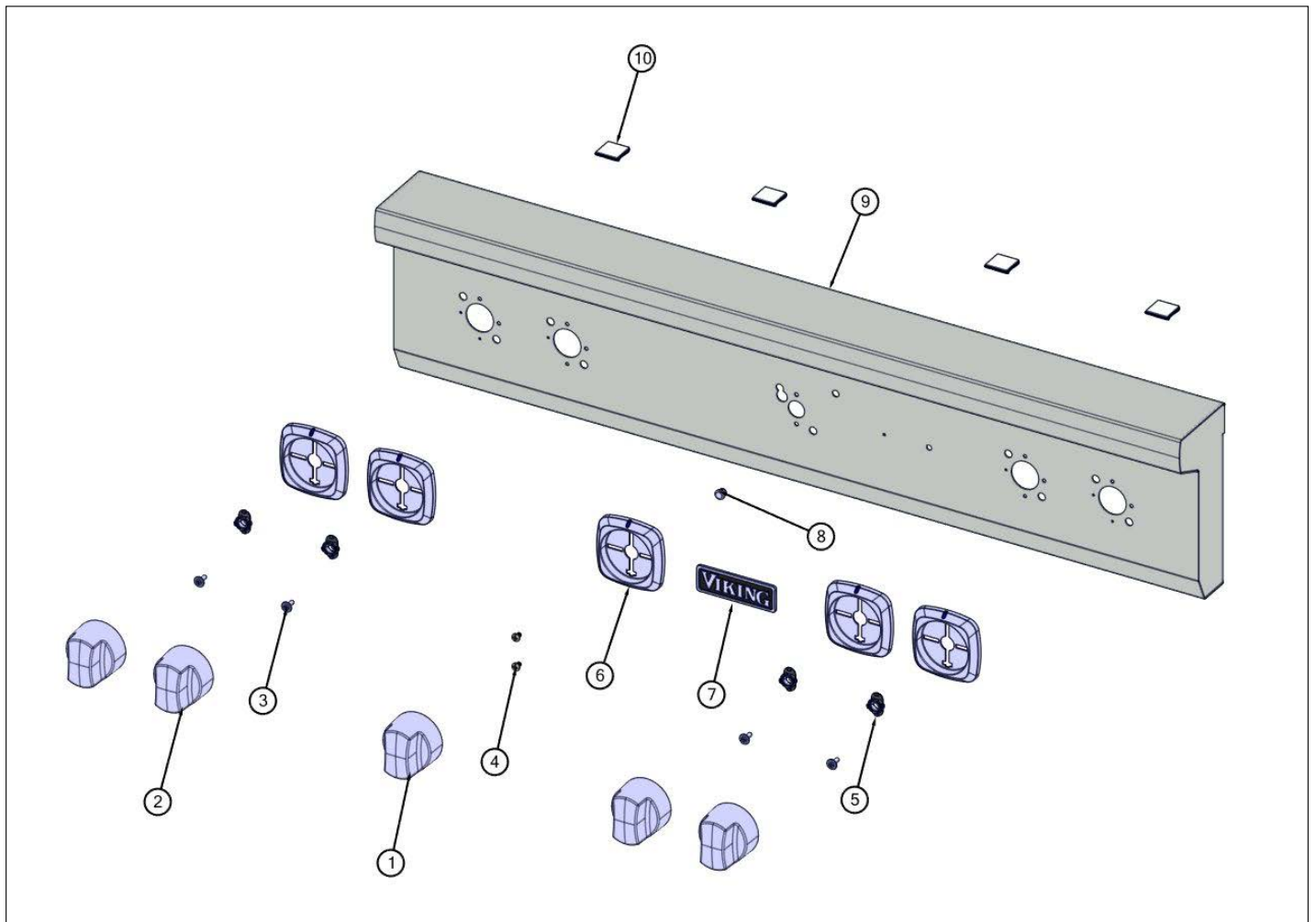



Item	Part No.	Name	Qty	Uom	NOTES
1	059005-2079	KNOB, GRDL, PRO ASSY	1	EA	
2	063759-2809	KNOB, BNR, TOP, PRO ASSY BLK CR (SEE 059023-000)	4	EA	
3	PD020046	' #8 X 1/2 SCREWS	4	EA	
4	PD020269	#8 PAN HEAD SCREW	2	EA	
5	044512-000	BEARING, BEZEL, ASM	4	EA	
6	048326-000	BZL, KNOB	5	EA	
7	062341-000	NAMEPLATE, VIKING, 3.500", W/LOC PINS	1	EA	
8	027968-000	INDICATOR, LIGHT, BLUE	1	EA	
9	064463-2822	PANEL, CTRL, WELD, VRT5364G, W/GRAPHICS	1	EA	
10	049878-000	CORD, CLIP, ADHESIVE	11	EA	

Surface Cooking View

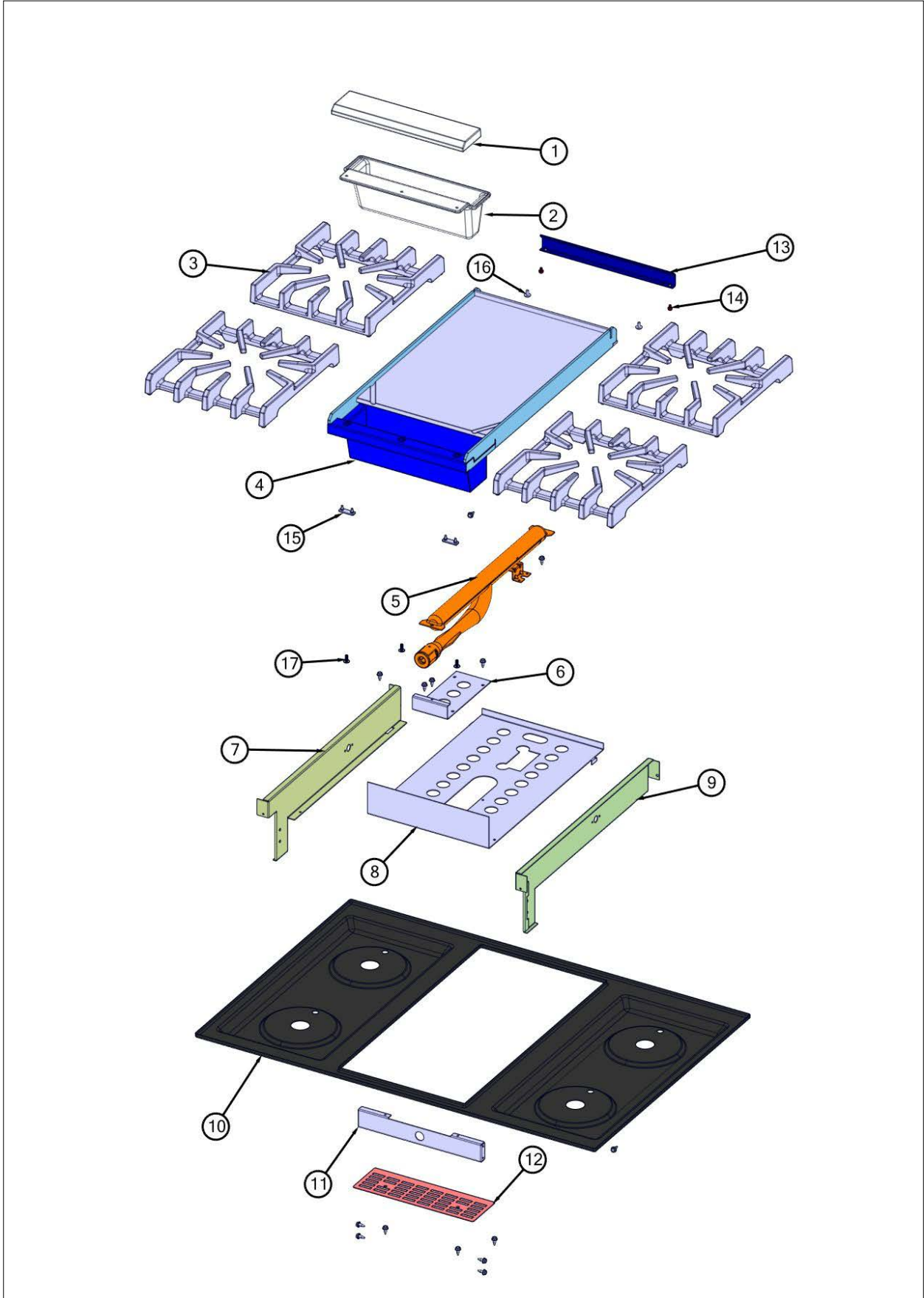



Item	Part No.	Name	Qty	Uom	NOTES
1	012927-000	TROUGH, TOP	1	EA	
2	023132-000	TROUGH, GRS	1	EA	
3	049420-000	GRATE, BURNER, ASM	4	EA	
4	057332-000	GRIDDLE, WELD, ASM	1	EA	
5	018649-000	BURNER ASM, GRIDDLE G20	1	EA	
6	006785-000	GRIDDLE, BOX, VENTURI, COVER	1	EA	
7	016293-000	GRIDDLE SUPPORT, LEFT	1	EA	
8	016292-000	BURNER BOX BOTTOM, GRILL	1	EA	
9	016295-000	SIDE, GRILL BOX, RH	1	EA	
10	E9108438BK	MAIN TOP (VGRT4G/Q) *BK*	1	EA	
11	037648-000	GRIDDLE ORIFICE BRACKET, 12"	1	EA	
12	037633-000	SHIELD, WIRE, 12"	1	EA	
13	015209-000	GRIDDLE, CVR, REAR, DCBZ, BLK	1	EA	
14	074892-000	FOOT, RUBBER	2	EA	
15	050355-000	CANOPY BUMPER, FD	2	EA	
16	PD020033	SRW-#10-24X1/2"T(23)PH.WFR HD (NKL)	2	EA	
17	PD020068	' #10 - 32 X 1/2"TRUSS. PHIL. M.*SS*	3	EA	

Gas Asm View

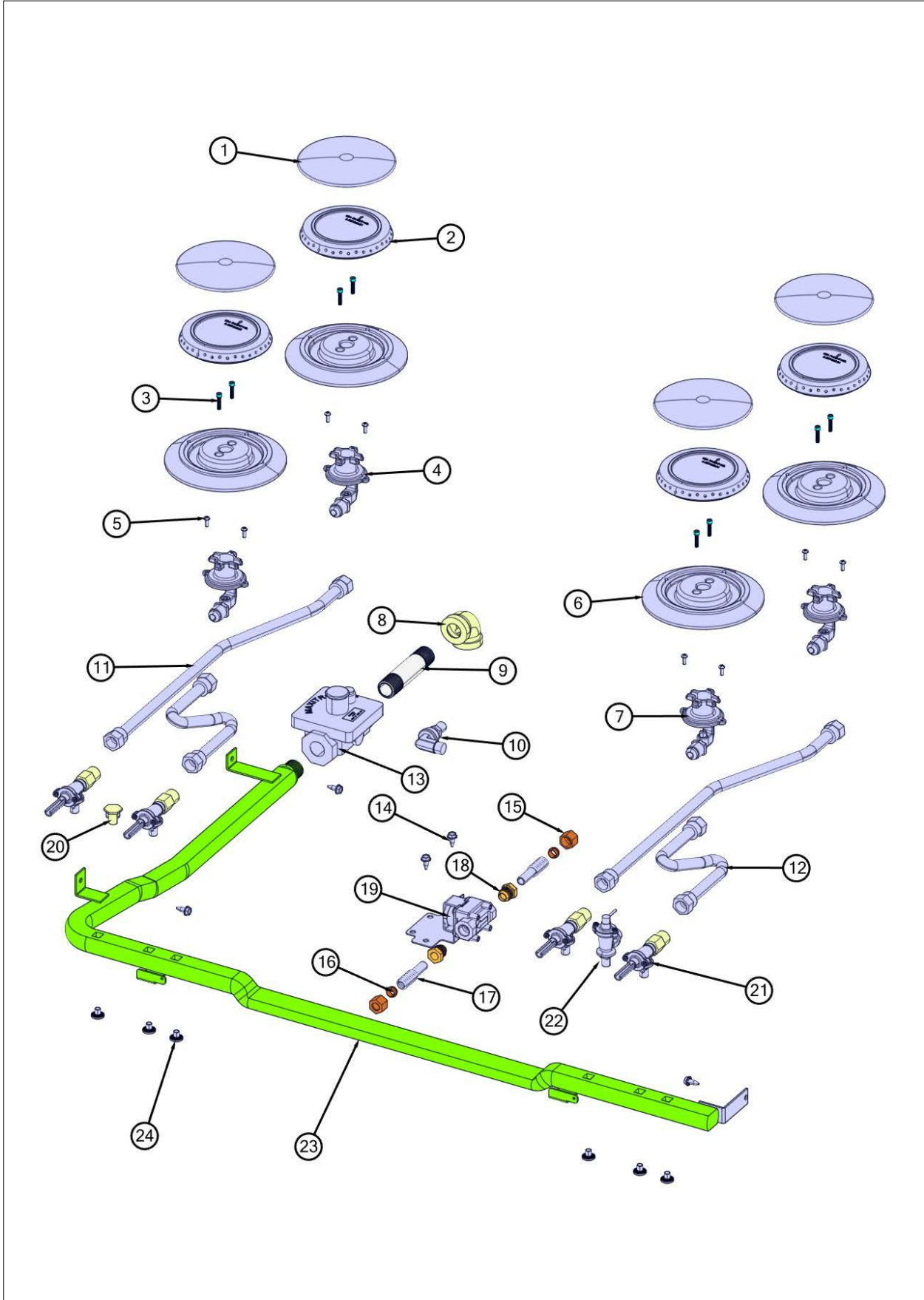

Item	Part No.	Name	Qty	Uom	NOTES
1	066958-000	D BURNER CAP *MATTE BLACK*	4	EA	
2	018200-000	ADJUSTED SEALED BURNER HEAD	4	EA	
3	009197-000	#6-32 X 5/8 18-8 SS NC SOC CAP	8	EA	
4	066197-042	15000 BTU NAT JETHOLDER	3	EA	
4	001394-046	12.5 K BTU LP JETHOLDER	3	EA	
5	PD020076	6-32 X 3/8" PHILL PAN MS	8	EA	
6	066810-042	BURNER, BASE, ASM, BLK	4	EA	
7	066197-041	18500 BTU NAT JETHOLDER	1	EA	
7	066197-044	16600 BTU LP JETHOLDER	1	EA	
8	PB040053	1/2" 90 DEG. ELBOW	1	EA	
9	019938-000	NIPPLE, 1/2" NPT X 3.5" LONG, STEEL	1	EA	
10	PB040190	90 DEGREE ORIFICE FITTING #50 NAT	1	EA	
11	PB020193	16" FLEX TUBING W/CONNECTORS	2	EA	
12	PB020192	10" FLEX TUBING W/CONNECTORS	2	EA	
13	013386-000	LP PRESSURE REGULATOR	1	EA	
13	PA070003	PRESSURE REGULATOR (NAT.)	1	EA	
14	003860-000	10-18 x .500 FASTNR,SCR,HXWH,STL,ZPLT	5	EA	
15	PB040213	3/8" COMPRESSION NUT (DGCU)	2	EA	
16	PB040192	3/8" CC FERREL (DGCU)	2	EA	
17	PB020126	3/8" S.S. FLEX TUBING 15" (DGCU)	2	EA	
18	PB040050	3/8CC MALE COMP. FITTING W/FERRULE	2	EA	
19	009111-000	VALVE, SOL, SINGLE	1	EA	
20	002884-000	MANIFOLD PLUG	1	EA	
21	061230-000	VALVE, BRS, ASM, TOP, BURNER, FLRE, FTG, 5/8-18 UNF	4	EA	
22	007147-000	SHUT OFF VALVE	1	EA	
23	058379-000	MANIFOLD, VGR5364G	1	EA	

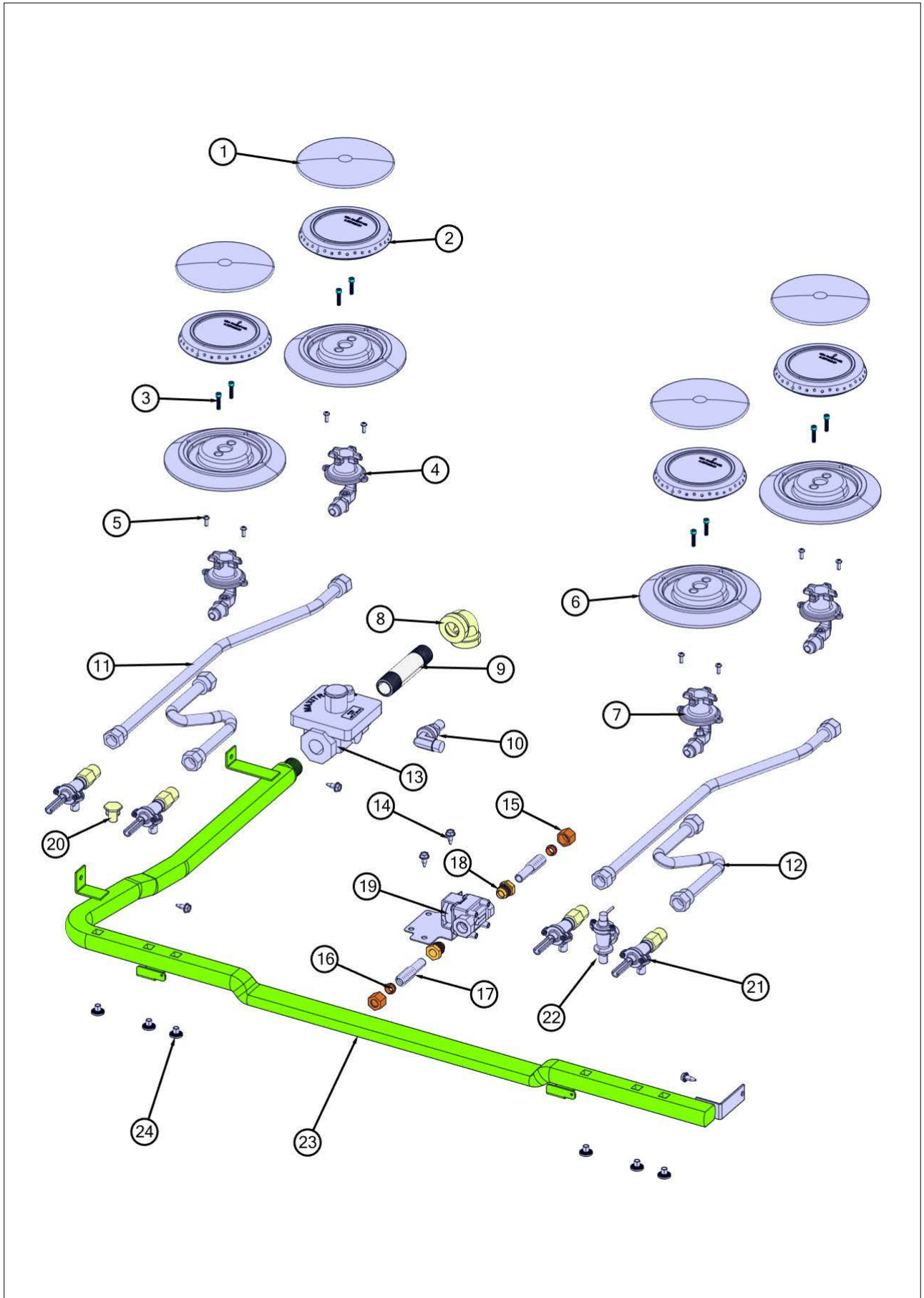



Item	Part No.	Name	Qty	Uom	NOTES
24	PD010012	VALVE BOLT 1/4-20 UNC-2B 5/16" M.S.	6	EA	

Electrical View

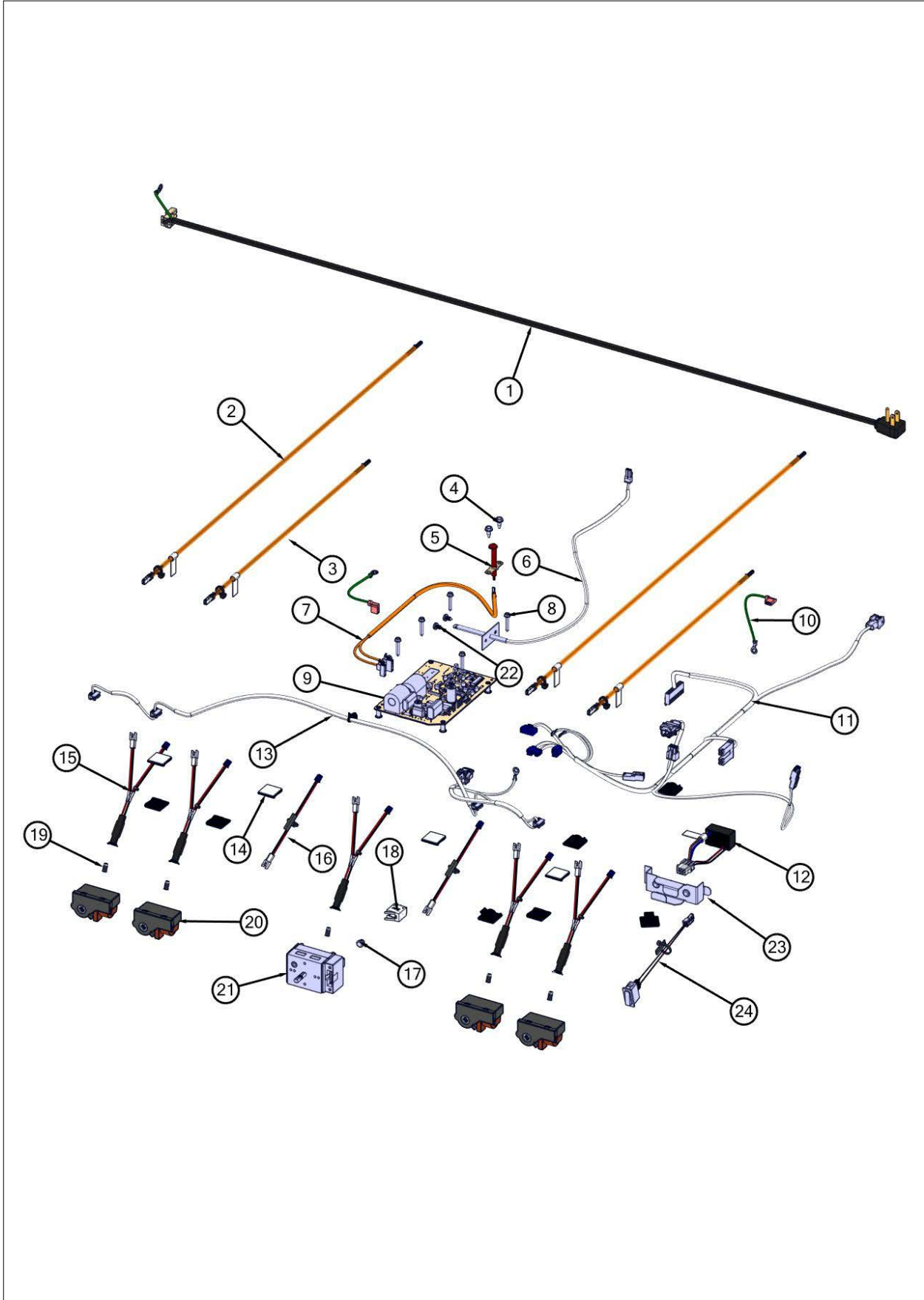



Item	Part No.	Name	Qty	Uom	NOTES
1	044747-000	CORD, SUPPLY, CORD	1	EA	
2	058659-604	HARN, VGR5, ELEC, BURN, REAR	2	EA	
3	058659-603	HARN, VGR5, ELEC, BURN, FRNT	2	EA	
4	003860-000	10-18 x .500 FASTNR,SCR,HXWH,STL,ZPLT	3	EA	
5	PA020028	SPARK IGNITER	1	EA	
6	059021-000	RTD, TE, 18IN	1	EA	
7	064537-000	HARN, VRT5, GRID, ELECTRODE	1	EA	
8	M0211021	SCREW-SM	5	EA	
9	043453-000	MODULE, DSI	1	EA	
10	043994-000	WIRE, GROUND, 5"	1	EA	
11	060218-000	HARN, VGRT536, MAIN, GRIDDLE	1	EA	
12	069994-000	12 Volt Power Supply Kit	1	EA	
Not Shown	NOTE	See TC-0118-SP Service Bulletin		EA	
13	059107-000	HARN, VGR5364G, IRIS	1	EA	
14	049878-000	CORD, CLIP, ADHESIVE	11	EA	
15	048809-000	LAMP, LED, 12VDC, 2.84K, WHITE, ASM	5	EA	
16	048482-000	HARNESS, LED, JUMPER (HPN-0923-1)	2	EA	
17	027968-000	INDICATOR, LIGHT, BLUE	1	EA	
18	043135-000	HOUSING, LIGHT, LED, BLUE, 3.3V	1	EA	
19	044937-000	LENS, COVER, LED, CLEAR	5	EA	
20	035795-000	MODULE, IGN, GAS,SNGL	4	EA	
21	013213-000	TSTAT, SMPS, ELEC, 2-POS, .91" SHAFT, CB	1	EA	
22	037304-000	FASTENER, PNH, TORX, AB, PSVD, WAX	2	EA	
23	068310-000	BRKT, SHELF, POWER SUPPLY	1	EA	
Not Shown	NOTE	See TC-0118-SP Service Bulletin		EA	
24	046283-000	SWITCH, LIGHTS, ACCENT W/CONN	1	EA	

Burner Box Asm View

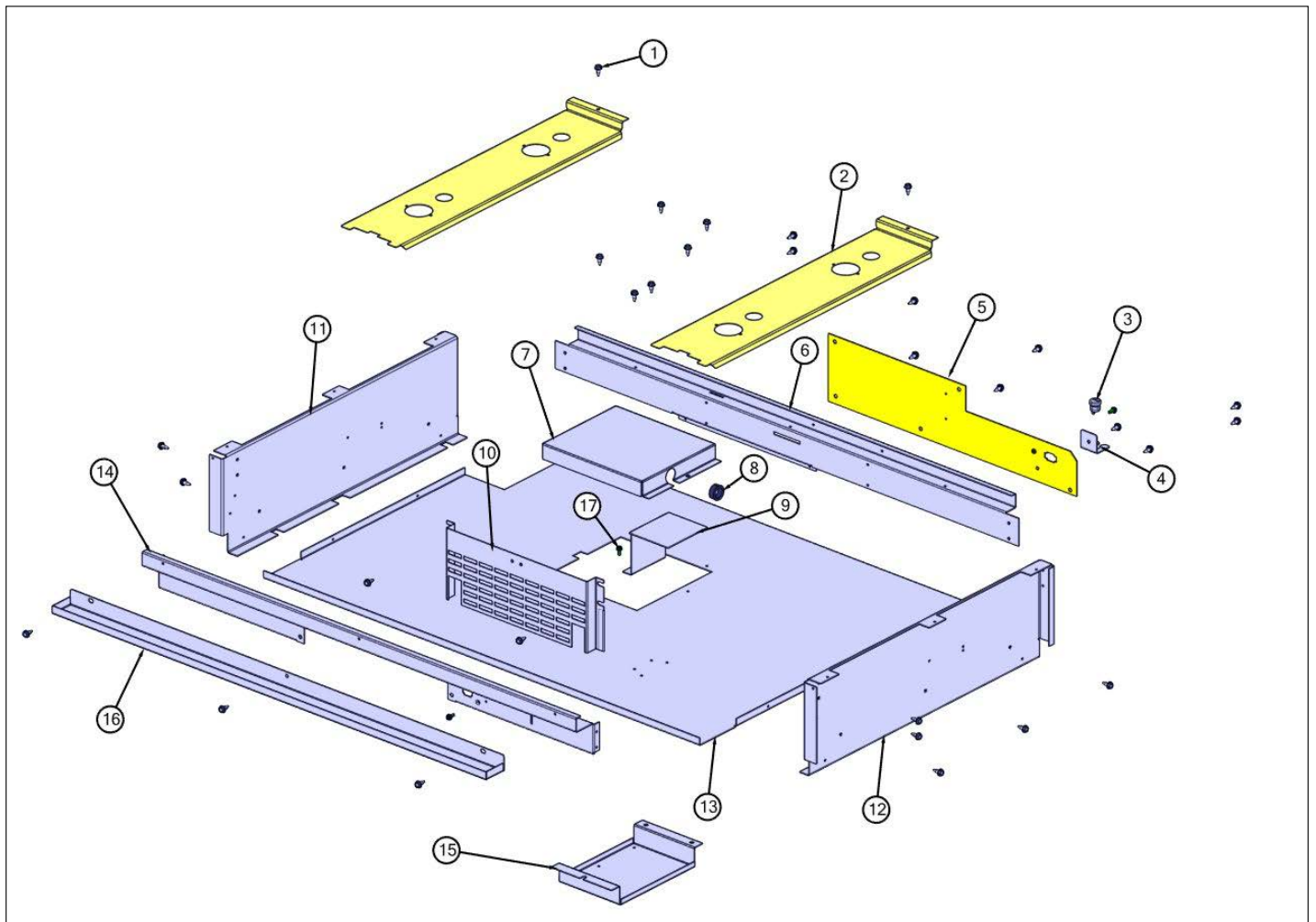



Item	Part No.	Name	Qty	Uom	NOTES
1	003860-000	10-18 x .500 FASTNR,SCR,HXWH,STL,ZPLT	32	EA	
2	002923-000	BURNER MODULE SUPPORT	2	EA	
3	PE070069	STRAIGHT-THRU BUSHING	1	EA	
4	064586-000	BRKT, STRN, RLF	1	EA	
5	064388-000	RANGE, TOP, PNL, BACK, VRT5304B	1	EA	
6	064445-000	SUPPORT, RNG, TOP, REAR, 36"	1	EA	
7	064455-000	COVER, DSI, VRT	1	EA	
8	PD040005	SNAP BUSHING - 7/8	1	EA	
9	009402-000	SOLENOID HEAT SHIELD COVER	1	EA	
10	018000-000	GRIDDLE PROTECTION SHIELD	1	EA	
11	003481-000	BURNER BOX SIDE, LH	1	EA	
12	002755-000	BURNER BOX SIDE, RH	1	EA	
13	064475-000	BOX, BNR, BOT, 36" VRT	1	EA	
14	064433-000	SUPPORT, RNG, TOP, FRONT, 36"	1	EA	
15	064454-000	BOARD, DSI, CRADLE	1	EA	
16	038899-000	GUTTER, SPILL, 36"	1	EA	
17	PD020010	10 X 3/8 GREEN GROUNDING SCREW	3	EA	

Decor View

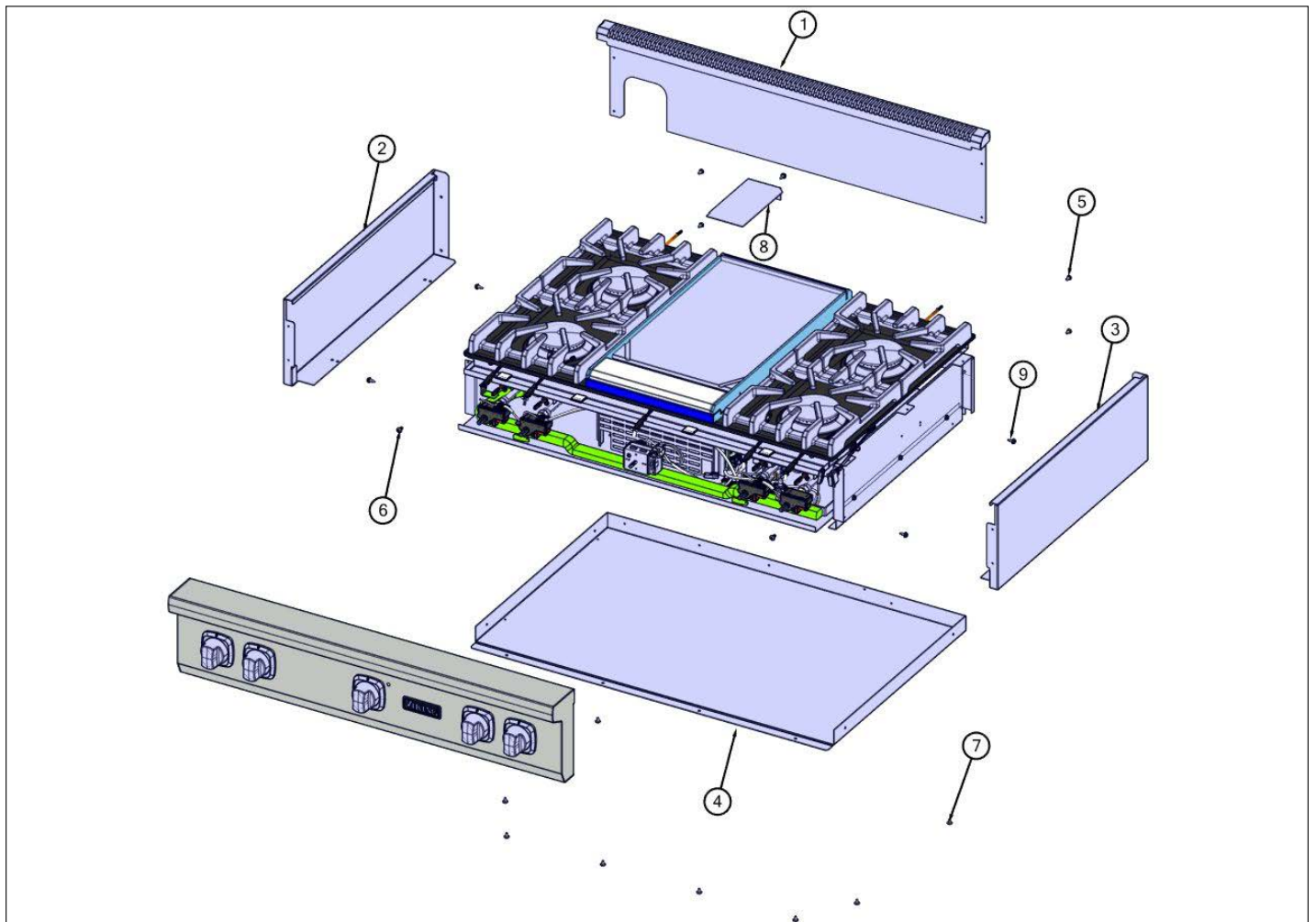



Item	Part No.	Name	Qty	Uom	NOTES
1	062400-000	TRIM, IS, WELD, ASM, 36"	1	EA	
2	063761-000	PANEL, LH, VRT5	1	EA	
3	063760-000	PANEL, RH, VRT5	1	EA	
4	064395-000	PANEL, BTM, VRT536	1	EA	
5	PD020004	10X3/8PH.HD.TYPE 25 REPL PD040125	4	EA	
6	003801-000	SHOULDER SCREW, #10	2	EA	
7	PD020032	SRW-8(A)X3/8"PH.WFR HD 7/16DIA*NICL	8	EA	
8	004016-000	PLATE, SVCE, RGLT	1	EA	
9	003860-000	10-18 x .500 FASTNR,SCR,HXWH,STL,ZPLT	32	EA	



Appendix A:Pages Index

Burner Box Asm View	5
Control View	1
Decor View	6
Electrical View	4
Gas Asm View	3
Surface Cooking View	2



Appendix B:Parts Index

001394-046	3	048809-000	4
002755-000	5	049420-000	2
002884-000	3	049878-000	1, 4
002923-000	5	050355-000	2
003481-000	5	057332-000	2
003801-000	6	058379-000	3
003860-000	3, 4, 5, 6	058659-603	4
004016-000	6	058659-604	4
006785-000	2	059005-2079	1
007147-000	3	059021-000	4
009111-000	3	059107-000	4
009197-000	3	060218-000	4
009402-000	5	061230-000	3
012927-000	2	062341-000	1
013213-000	4	062400-000	6
013386-000	3	063759-2809	1
015209-000	2	063760-000	6
016292-000	2	063761-000	6
016293-000	2	064388-000	5
016295-000	2	064395-000	6
018000-000	5	064433-000	5
018200-000	3	064445-000	5
018649-000	2	064454-000	5
019938-000	3	064455-000	5
023132-000	2	064463-2822	1
027968-000	1, 4	064475-000	5
035795-000	4	064537-000	4
037304-000	4	064586-000	5
037633-000	2	066197-041	3
037648-000	2	066197-042	3
038899-000	5	066197-044	3
043135-000	4	066810-042	3
043453-000	4	066958-000	3
043994-000	4	068310-000	4
044512-000	1	069994-000	4
044747-000	4	074892-000	2
044937-000	4	E9108438BK	2
046283-000	4	M0211021	4
048326-000	1	PA020028	4
048482-000	4	PA070003	3
		PB020126	3



PB020192	3
PB020193	3
PB040050	3
PB040053	3
PB040190	3
PB040192	3
PB040213	3
PD010012	3
PD020004	6
PD020010	5
PD020032	6
PD020033	2
PD020046	1
PD020068	2
PD020076	3
PD020269	1
PD040005	5
PE070069	5