

VRT7486GSS

Control View	1
Gas Asm View	2
Decor View	3
Surface Cooking View	4
Electrical View	5
Appendix A:Pages Index	A
Appendix B:Parts Index	B

Control View

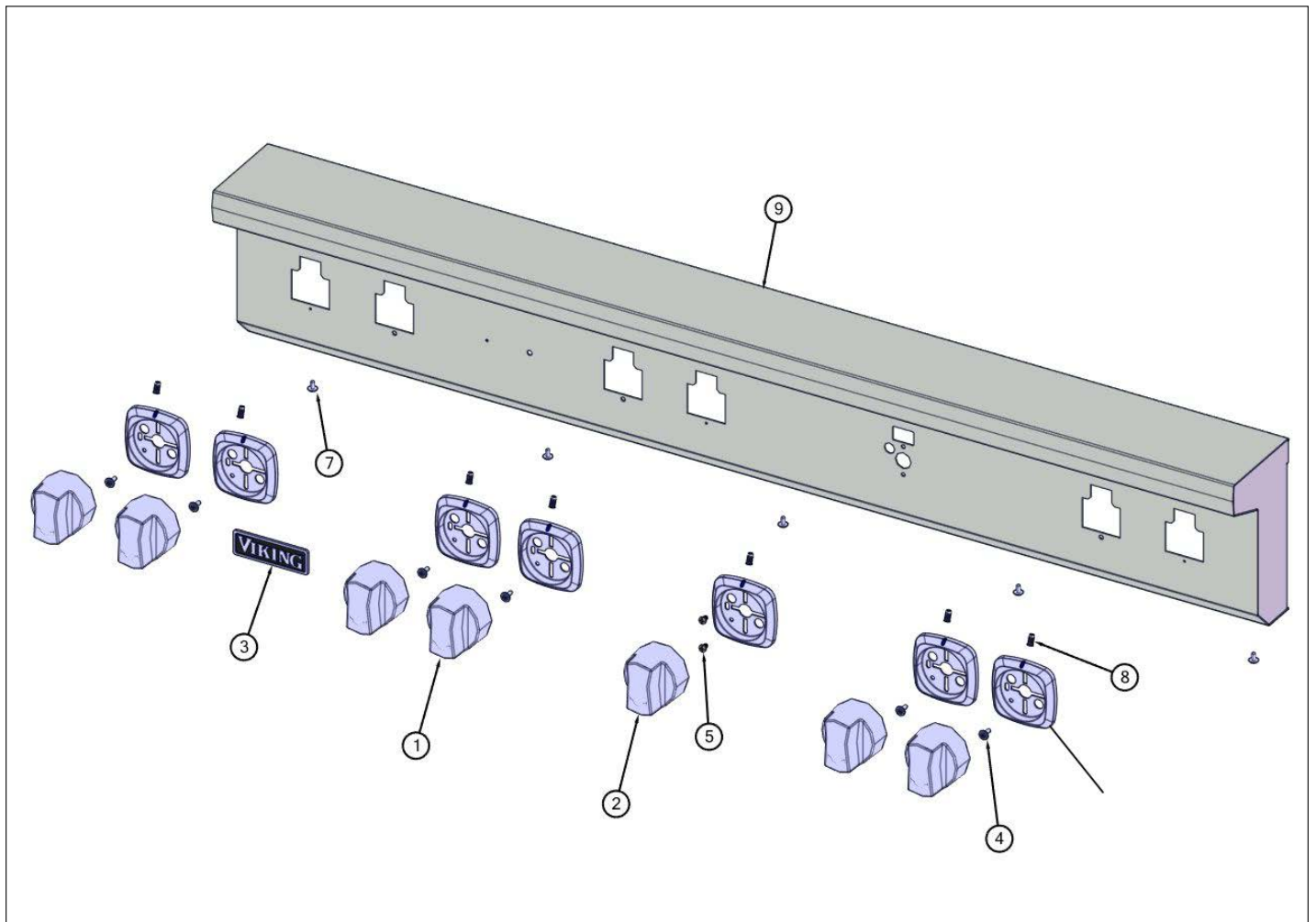



Item	Part No.	Name	Qty	Uom	NOTES
1	061041-000	KNOB, BURNER, ASSY (SEE 042558-000)	6	EA	
2	067119-2617	KNOB, THERMOSTAT, GRIDDLE, ASSY W/GRAPHICS (SEE 067117-000)	1	EA	
3	062341-000	NAMEPLATE, VIKING, 3.500", W/LOC PINS	1	EA	
4	PD020046	' #8 X 1/2 SCREWS	6	EA	
5	PD020269	#8 PAN HEAD SCREW	2	EA	
6	061090-501	BEZEL, ASSY, LED, SQUARE, LARGE	7	EA	
Comments for Part Num. 061090-501					
profixappliances@gmail.com on Feb 27, 2020					
SEE SERVICE BULLETIN TC-0126-SP REGARDING NEW BEZELS					
7	PD020032	SRW-8(A)X3/8"PH.WFR HD 7/16DIA*NICL	6	EA	
8	044937-000	LENS, COVER, LED, CLEAR	7	EA	
9	064725-2646	ASM, WELD, PANEL, CONTROL, VRT7486G W/GRAPHICS	1	EA	

Gas Asm View

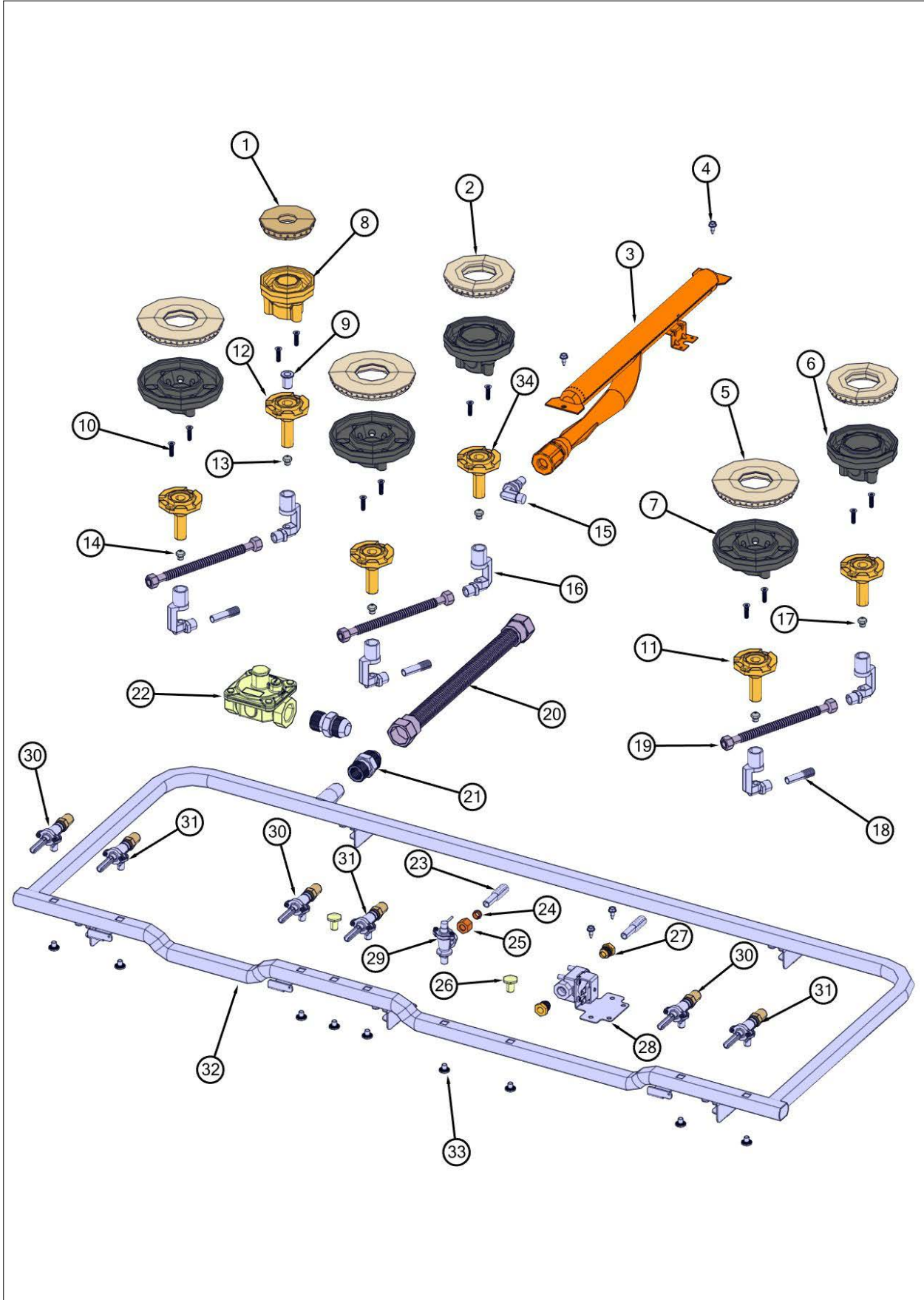



Item	Part No.	Name	Qty	Uom	NOTES
1	056256-000	BURNER, HEAD, BRS, C-SIZE	1	EA	
2	066169-000	BURNER, HEAD, D W/GRAPHICS	2	EA	
3	046133-000	BURNER, GRIDDLE, 700- SERIES	1	EA	
4	003860-000	10-18 x .500 FASTNR,SCR,HXWH,STL,ZPLT	4	EA	
5	066172-000	BURNER HEAD, E	3	EA	
6	066105-000	BASE, BNR, D	2	EA	
7	053357-000	BASE, BNR, E-SIZE	3	EA	
8	066177-000	BASE, BNR, C-SIZE	1	EA	
9	051541-000	C VENTURI INSERT	1	EA	
10	046964-000	SCREW, 10-32 X 3/4", CTSK, BLACK	12	EA	
11	044485-000	VENTURI, E NAT, FLANGE, BNR	3	EA	
12	044686-000	VENTURI, C NAT, C LP, FLANGE, BNR	1	EA	
13	044688-000	ORIFICE, BNR, STD, 1.22MM	1	EA	
14	043675-000	ORIFICE, BNR, STD, 2.18MM	3	EA	
15	PB040190	90 DEGREE ORIFICE FITTING #50 NAT	1	EA	
16	063295-000	HOLDER, JET, BURNER	6	EA	
17	046184-000	ORIFICE, BNR, STD, 1.70MM	2	EA	
18	PB020191	15" FLEX TUBE	3	EA	
19	PB020198	20" FLEX TUBING	3	EA	
20	044310-000	TUBING, 3/4" FLEX, SST, 13"	1	EA	
21	044321-000	FITTING, ADAPTOR, 3/4" FLEX TUBING	2	EA	
22	046119-000	PRESSURE REGULATOR (NAT)	1	EA	
23	PB020126	3/8" S.S. FLEX TUBING 15" (DGCU)	2	EA	
24	PB040192	3/8" CC FERREL (DGCU)	1	EA	
25	PB040213	3/8" COMPRESSION NUT (DGCU)	1	EA	
26	002884-000	MANIFOLD PLUG	2	EA	
27	PB040050	3/8"CC MALE COMP. FITTING W/FERRULE	2	EA	

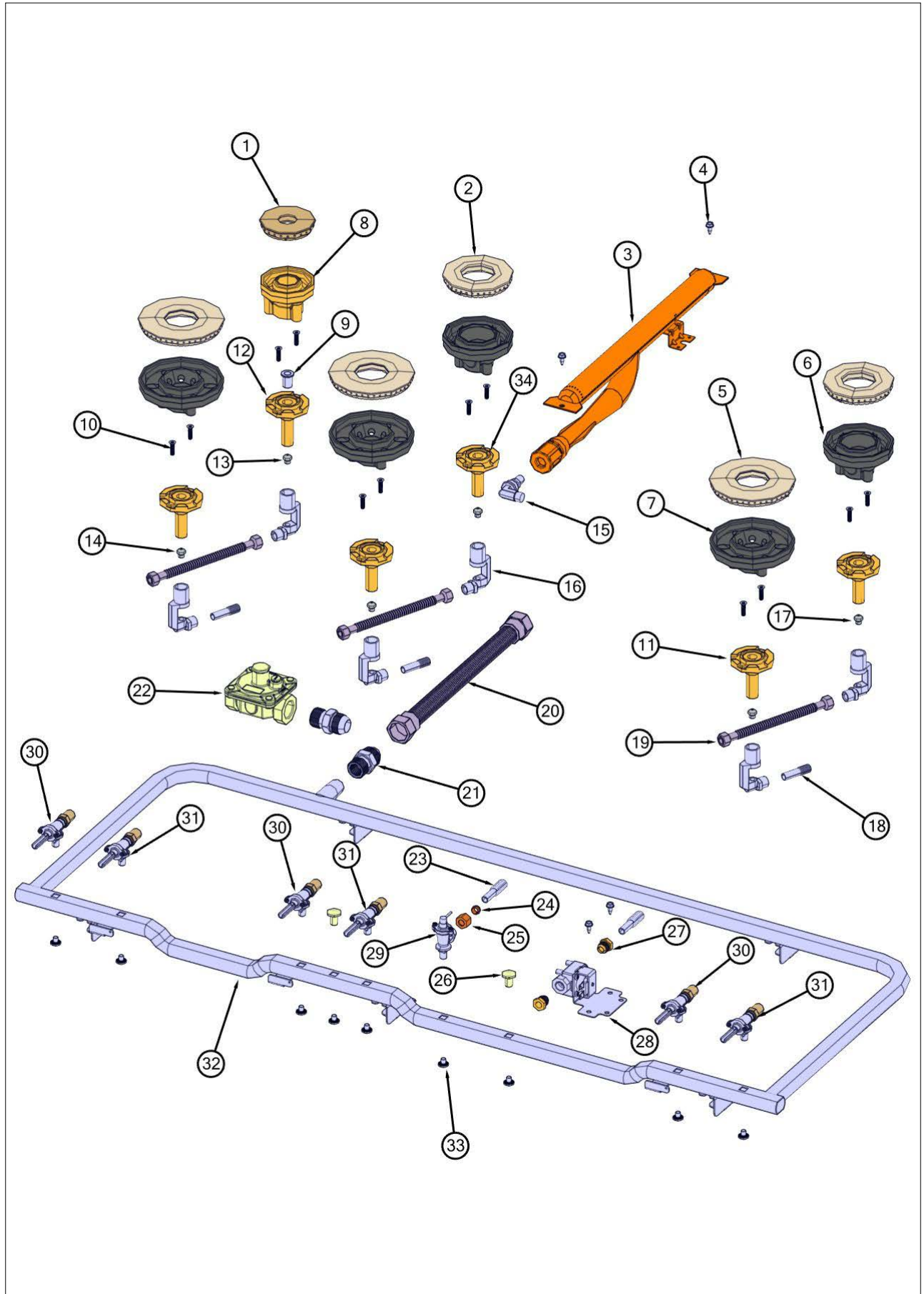



Item	Part No.	Name	Qty	Uom	NOTES
28	009111-000	VALVE, SOL, SINGLE	1	EA	
29	PB030007	SHUT OFF VALVE	1	EA	
30	061224-000	VALVE, GAS, E-BNR, NAT	3	EA	
31	061225-000	VALVE, GAS, C & D-BNR, NAT	3	EA	
32	056463-000	MANIFOLD, GRIDDLE, GAS, 48", ASM	1	EA	
33	PD010012	VALVE BOLT 1/4-20 UNC-2B 5/16" M.S.	9	EA	
34	066171-000	VENTURI, D NAT, D LP, FLANGE, BNR	2	EA	

Decor View

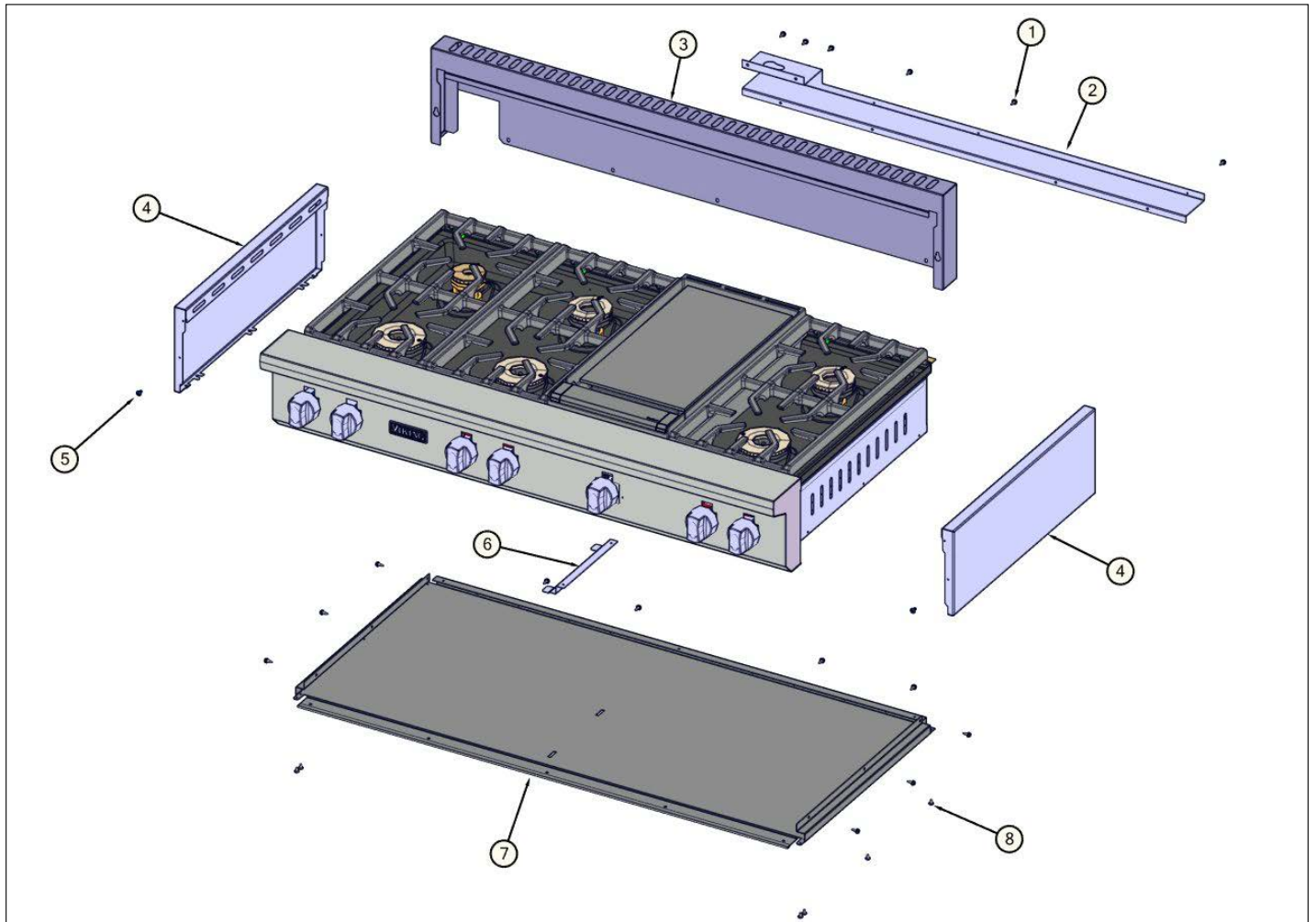



Item	Part No.	Name	Qty	Uom	NOTES
1	003860-000	10-18 x .500 FASTNR,SCR,HXWH,STL,ZPLT	16	EA	
2	068205-000	SHIELD, BRKT, VRT748	1	EA	
3	042797-000	TRIM, IS, VGR, 48"	1	EA	
4	052892-000	COVER, OS, RH/LH UPPER	2	EA	
5	014143-000	SCR 10-12 A SHLD TRP 1/2 S ZN BLUE	2	EA	
6	046508-000	BRACKET, SPRT, BOT	1	EA	
7	046117-000	RANGETOP, PANEL, BOTTOM, VGRT748	1	EA	
8	PD020032	SRW-8(A)X3/8"PH.WFR HD 7/16DIA*NICL	6	EA	

Surface Cooking View

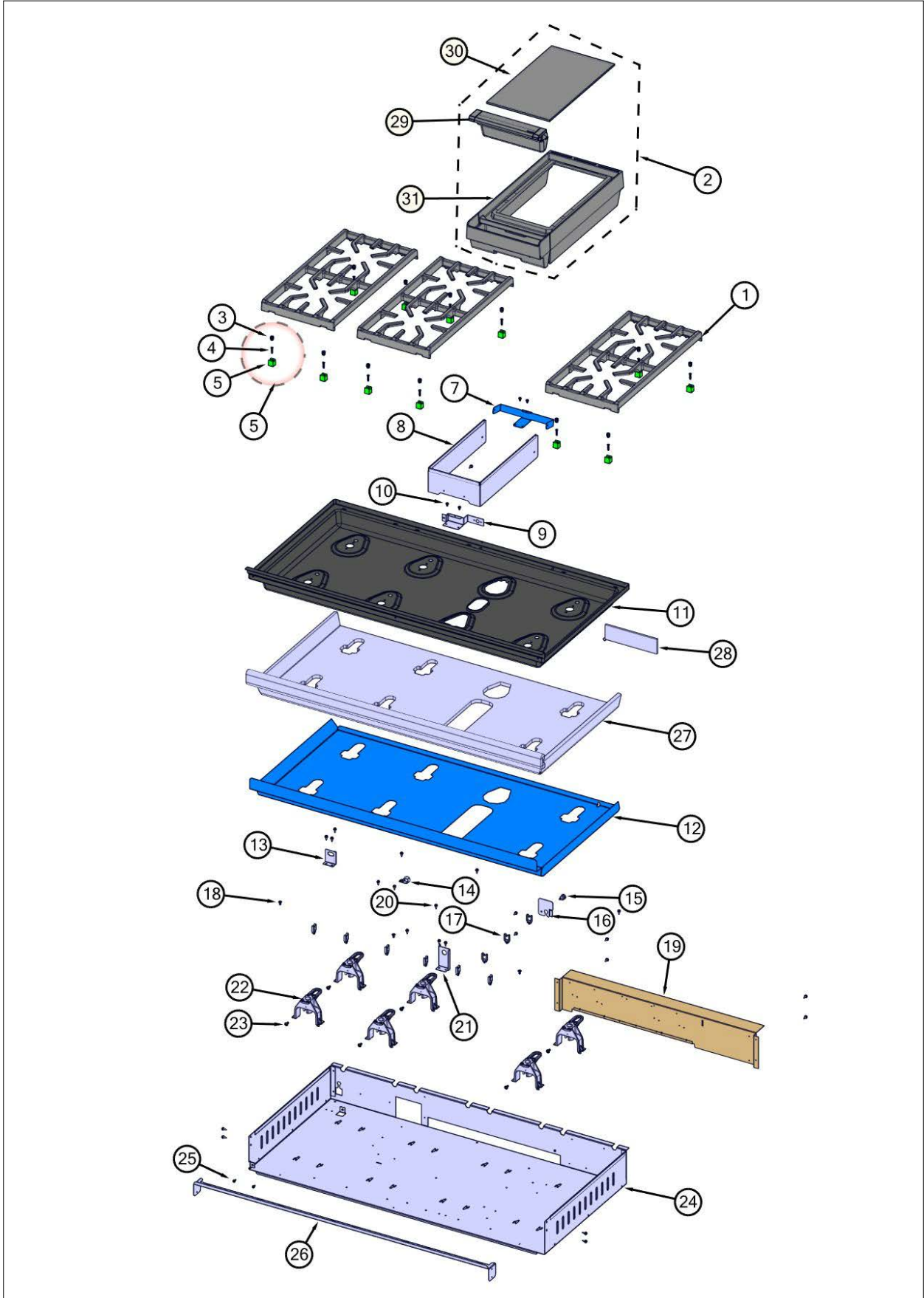



Item	Part No.	Name	Qty	Uom	NOTES
1	042545-000	GRATE, CAST, 12"	3	EA	
2	066471-000	ASM, GRIDDLE	1	EA	
3	052260-000	SILENCER, GRATE	12	EA	
4	049534-000	SCREW, 8-32 X 3/4, PHIL, FLAT	12	EA	
5	052259-000	SUPPORT, GRATE	12	EA	
6	058147-000	GRATE, LEG, ASSY, PHASE 2 (BLK)	12	EA	
<p>Comments for Part Num. 058147-000</p> <p>gboltz@VikingRange.com on Jun 6, 2016</p> <p>See parts bulletin 2016-03P Grate support changes</p>					
7	052295-000	HOLDER, BNR, REAR	1	EA	
8	046854-000	SHIELD, HEAT	1	EA	
9	066343-000	BRKT, BRNR, SPT	1	EA	
10	037304-000	FASTENER, PNH, TORX, AB, PSVD, WAX	4	EA	
11	049053-402	PAN, BNR, SHIM, ASM, BLK, 48" GRIDDLE	1	EA	
12	049749-000	TRAY, INSULATION, BURNER PAN, GRIDDLE, 48"	1	EA	
13	033668-000	BRACKET, DISCONNECT	1	EA	
14	pd030109	INSULATED CLAMP	1	EA	
15	pe070069	STRAIGHT-THRU BUSHING	1	EA	
16	049959-000	CVR, STRN, RELIEF	1	EA	
17	045548-000	CLIP, ROUTING, WIRE	9	EA	
18	014143-000	SCR 10-12 A SHLD TRP 1/2 S ZN BLUE	3	EA	
19	065157-000	BRKT, MNTG, EGRID, VRT748	1	EA	
20	003860-000	10-18 x .500 FASTNR,SCR,HXWH,STL,ZPLT	13	EA	
21	045888-000	BRKT, GRDL	1	EA	
22	066170-000	SUPPORT, HLDR, JET	6	EA	
23	PD020068	' #10 - 32 X 1/2"TRUSS. PHIL. M.*SS*	6	EA	
24	064981-000	BOX, BNR, VRT748	1	EA	
25	PD020010	10 X 3/8 GREEN GROUNDING SCREW	2	EA	

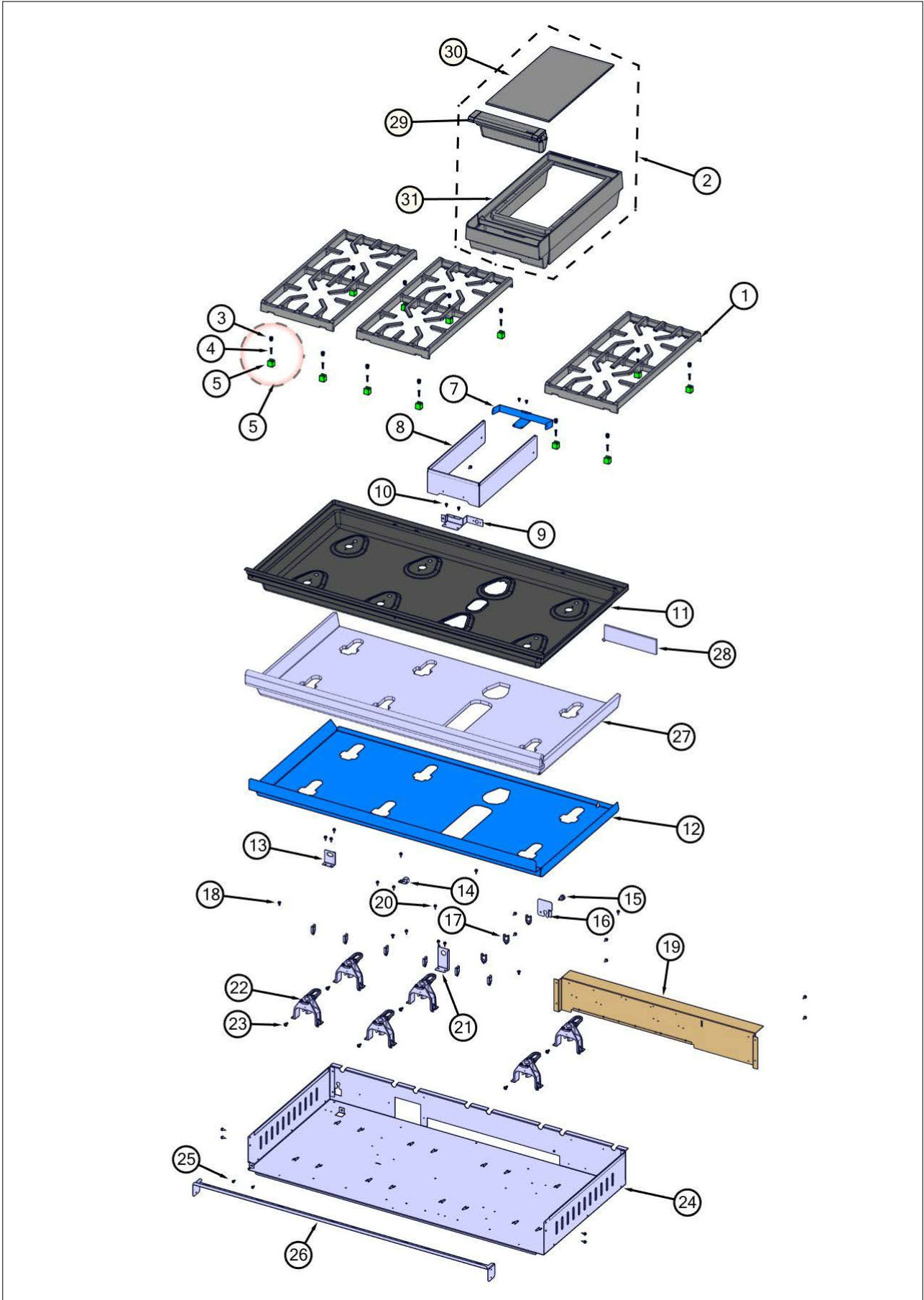



Item	Part No.	Name	Qty	Uom	NOTES
26	049728-000	BRACKET, MTG, 48" CONTROL PANEL	1	EA	
27	049776-000	INSULATION, LINER, GRIDDLE, BURNER PAN, 48"	1	EA	
28	049797-000	INSULATION, 1/4", ADHESIVE BACKED	1	EA	
29	066839-000	TROUGH, GRS, GRIDDLE, ASM	1	EA	
30	054388-000	PLATE, REVERSIBLE, NON-STICK, GRILL, GRIDDLE	1	EA	
31	047069-000	BASE, SUMP, GRIDDLE, ASM	1	EA	

Electrical View

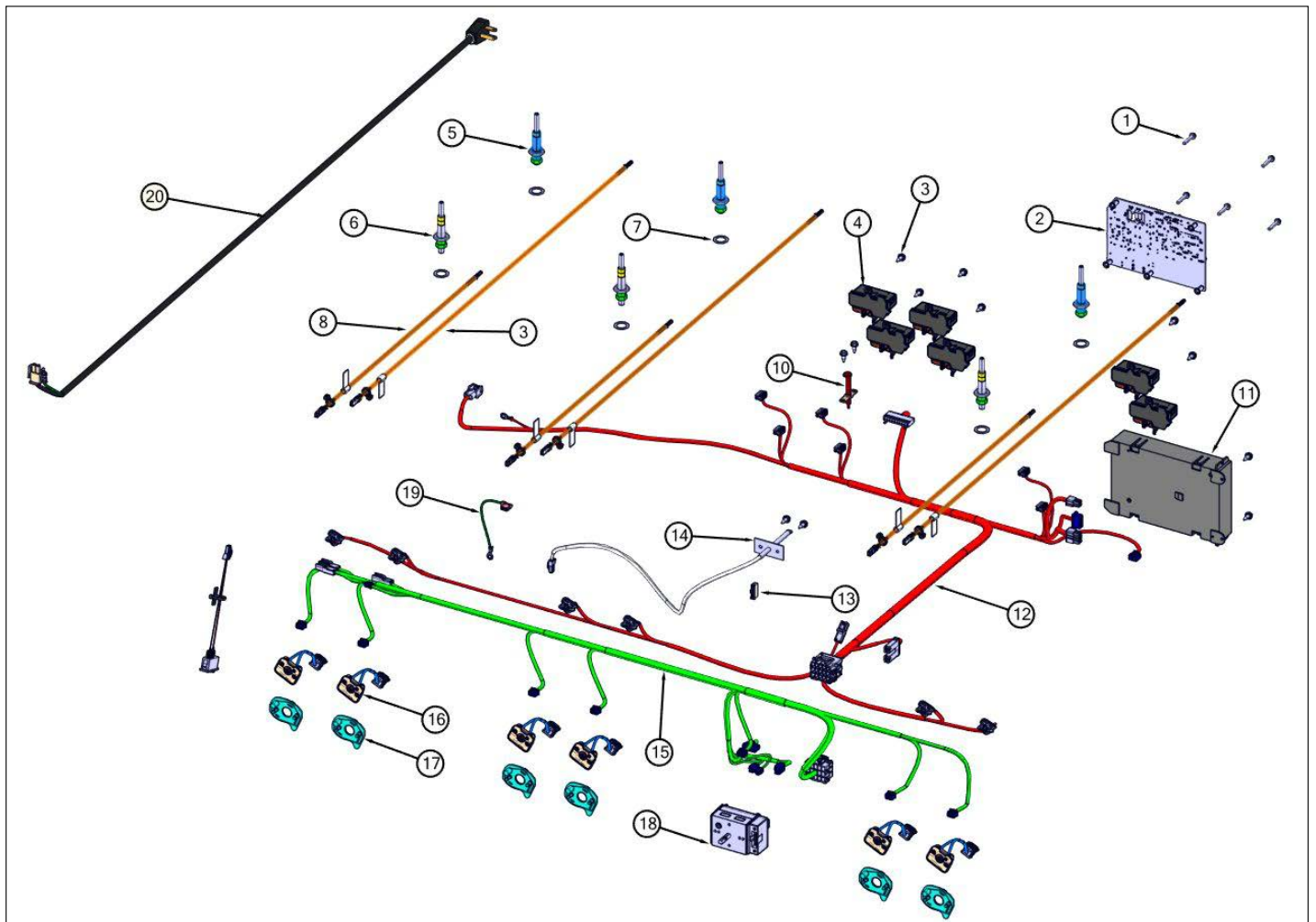



Item	Part No.	Name	Qty	Uom	NOTES
1	M0211021	SCREW-SM	5	EA	
2	043453-000	MODULE, DSI	1	EA	
3	003860-000	10-18 x .500 FASTNR,SCR,HXWH,STL,ZPLT	12	EA	
4	062214-000	EGRID, REMOTE MOUNT, 120VAC	6	EA	
5	066808-000	ELECTRODE , ASM, D	3	EA	
6	066809-000	ELECTRODE, ASM E	3	EA	
7	045932-000	WASHER, ELECTRODE	6	EA	
8	058659-603	HARN, VGR5, ELEC, BURN, FRNT	3	EA	
9	058659-604	HARN, VGR5, ELEC, BURN, REAR	3	EA	
10	PA020028	SPARK IGNITER	1	EA	
11	062885-501	CNTRL, MODULE, ULC	1	EA	
12	061266-000	HARN, VRT7486G, MAIN	1	EA	
13	038655-000	GRIDDLE,JUMPER,BRIGADE	1	EA	
14	059021-000	RTD, TE, 18IN	1	EA	
15	061265-000	HARN, VRT7486G, CP	1	EA	
16	061211-000	SWITCH, VALVE, SPST, 2 PIN CON	6	EA	
17	063640-000	ADAPTER, BEZEL, LED	6	EA	
18	065702-579	TSTAT, SMPS, ELEC, 2-POS	1	EA	
19	043994-000	WIRE, GROUND, 5"	1	EA	
20	044747-000	CORD, SUPPLY, CORD	1	EA	



Appendix A:Pages Index

Control View	1
Decor View	3
Electrical View	5
Gas Asm View	2
Surface Cooking View	4



Appendix B:Parts Index

002884-000	2	052295-000	4
003860-000	2, 3, 4, 5	052892-000	3
009111-000	2	053357-000	2
014143-000	3, 4	054388-000	4
033668-000	4	056256-000	2
037304-000	4	056463-000	2
038655-000	5	058147-000	4
042545-000	4	058659-603	5
042797-000	3	058659-604	5
043453-000	5	059021-000	5
043675-000	2	061041-000	1
043994-000	5	061090-501	1
044310-000	2	061211-000	5
044321-000	2	061224-000	2
044485-000	2	061225-000	2
044686-000	2	061265-000	5
044688-000	2	061266-000	5
044747-000	5	062214-000	5
044937-000	1	062341-000	1
045548-000	4	062885-501	5
045888-000	4	063295-000	2
045932-000	5	063640-000	5
046117-000	3	064725-2646	1
046119-000	2	064981-000	4
046133-000	2	065157-000	4
046184-000	2	065702-579	5
046508-000	3	066105-000	2
046854-000	4	066169-000	2
046964-000	2	066170-000	4
047069-000	4	066171-000	2
049053-402	4	066172-000	2
049534-000	4	066177-000	2
049728-000	4	066343-000	4
049749-000	4	066471-000	4
049776-000	4	066808-000	5
049797-000	4	066809-000	5
049959-000	4	066839-000	4
051541-000	2	067119-2617	1
052259-000	4	068205-000	3
052260-000	4	M0211021	5
		PA020028	5



PB020126	2
PB020191	2
PB020198	2
PB030007	2
PB040050	2
PB040190	2
PB040192	2
PB040213	2
PD010012	2
PD020010	4
PD020032	1, 3
PD020046	1
PD020068	4
PD020269	1
pd030109	4
pe070069	4